

GIRA

Smart Home.
Smart Building.
Smart Life.

partner.gira.com

The new Gira
switch generation.
Versatile new
features down to
the last detail.



Gira / Design & function

We are Gira.
We are the ones with the switches.
But we're so much more.

Future-oriented.
Certified.
Responsible.

We're the guardians, innovators,
smart home pioneers, developers,
system experts, KNX partners,
shapers of the future, patent masters,
award winners and designers.

But above all, we're the ones
who listen.
To you.

Subtle, but smart.
With distinct focus on quality,
materials and functions.
And the driving force of innovation.

In our hearts, we are engineers
on a mission to inspire.
With new technologies,
smart applications, and
impressive attention to detail.

We will always work our hardest
to find the best solution for you.
With service, design and performance
made in Germany.

Because that is what we stand for.
And have been standing for since 1905.

04	_____	Introduction
06	_____	Highlights
08	_____	Function
10	_____	Design
12	_____	Overview
16	_____	Item overview
29	_____	Services
30	_____	Company

Switching up to the next level.

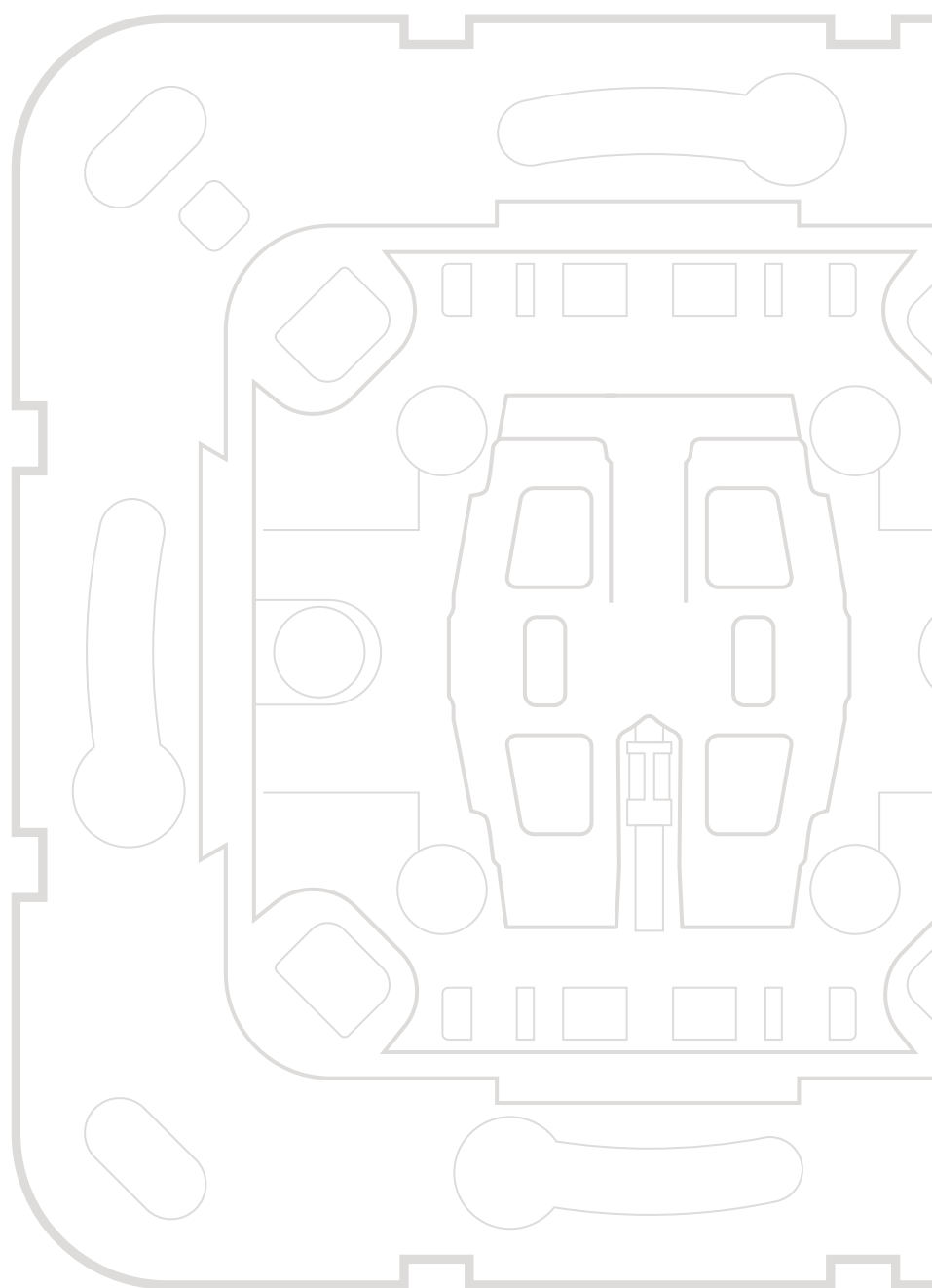

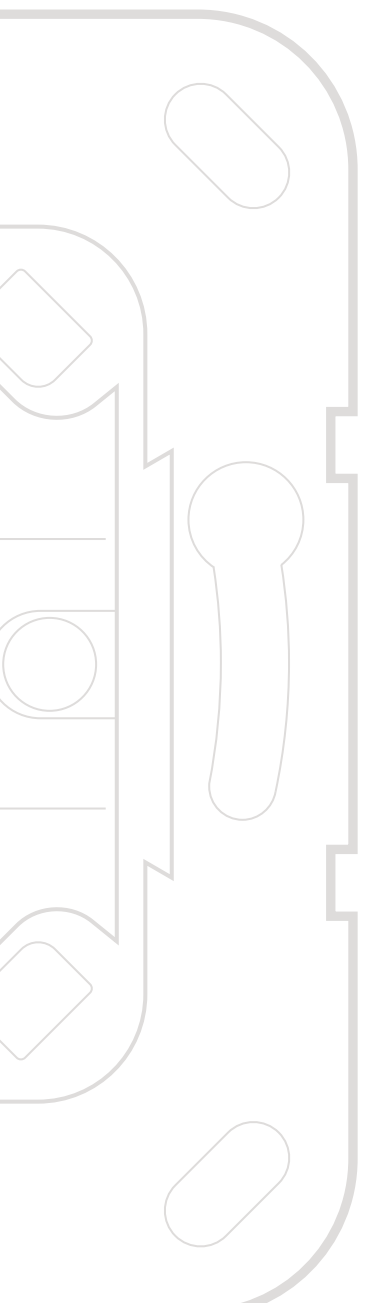

The new generation of Gira switches has been completely redeveloped and impresses with sum of numerous improvements. The entire range has been reworked and optimised down to the last detail, resulting in fewer products that offer more functions to combine. Manufactured in Germany to the highest quality specifications, this new generation of switches goes far beyond the required VDE standards and is replacing the previous range in its entirety.



01

Simplified installation. Improved handling.

To make everyday work easier and speed up processes, key aspects of the design of the switching insert have been modified. Among the improvements is a standardised rocker holder.



02

⊕ Highlights, facts and benefits of the new Gira switch generation:

Optimised inventory management thanks to standardised rocker holder for rocker switches, rocker buttons and pushbutton switches.

Greater installation convenience.

More flexibility and combination options: the entire spectrum of products is now also available for the pushbutton switch.

Item no.:

01 310600

02 329603

Refined down to the smallest detail.

Floating switch rocker ensures automatic and precise positioning of the rocker in the frame

Quick mounting (3.5 turns per mounting claw)

Claw mounting made easier thanks to robust PZ1 / slotted / PH screw head drive

Voltage test possible from the front

Item no. 310600

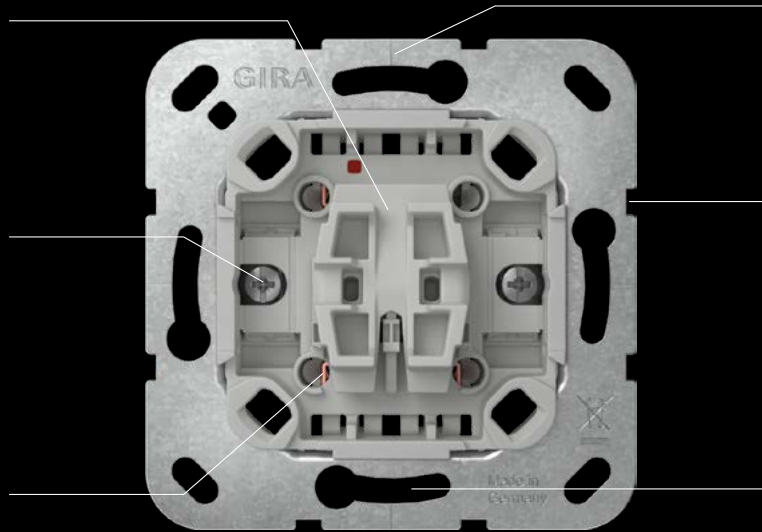

Markings for central alignment when there are several flush-mounted inserts

Levelling aid for multi-gang installation

Large keyhole profiles in a patented, opposing arrangement makes the insert easy to align even if the flush-mounted boxes are not properly mounted

Base marked by high-contrast, easy-to-read laser inscriptions

Conductor insertion at the rear

Item no. 310600

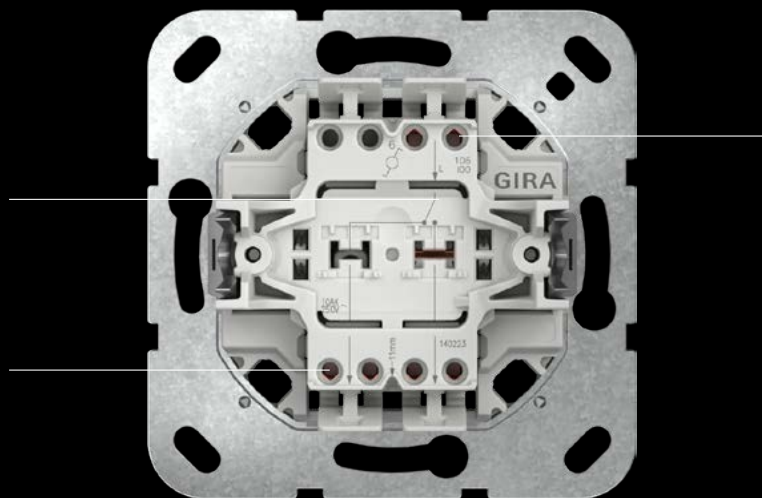

Uniform stripping length (11 mm) for switches and socket outlets makes mounting faster and more efficient.

Rigid or flexible conductors can be used

Installation-friendly, shallow plinth installation depth (only 28 mm with conductor material or 23 mm from the support ring to the underside of the plinth)

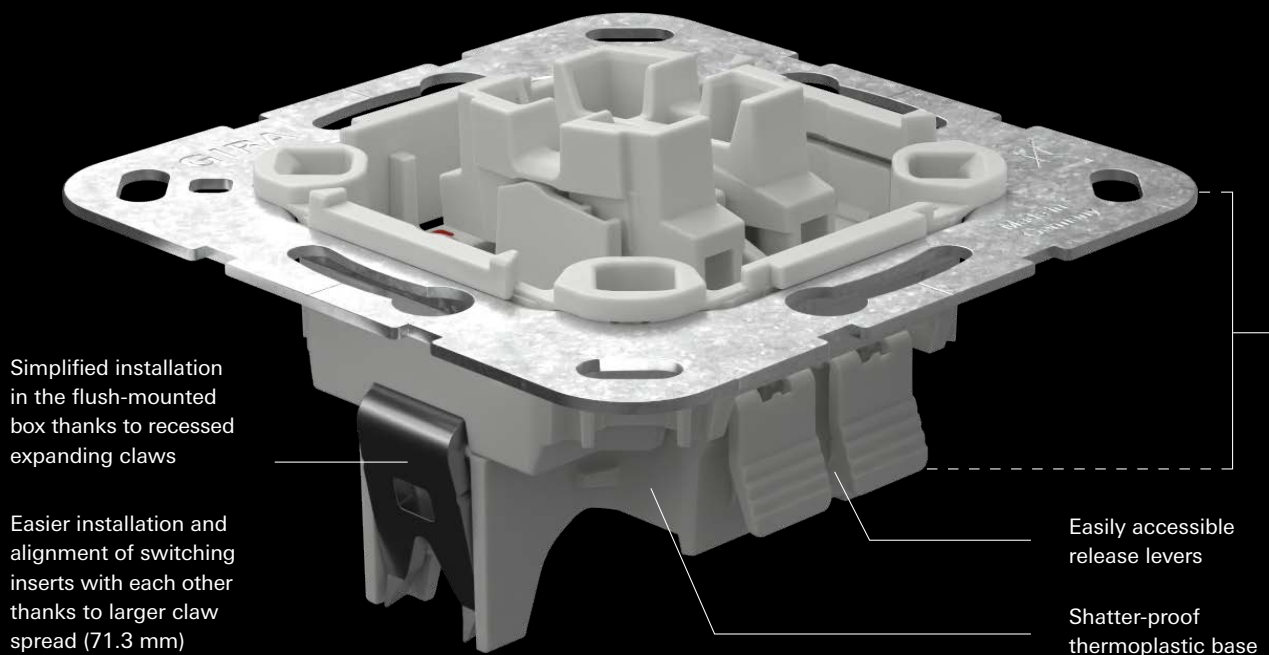

Item no. 310600

Turning the lighting element by 180° allows switching between control lighting and continuous lighting, depending on the switch



Item no. 311200

Tangible differences in the details.

The new switch generation
from Gira exhibits a compelling,
high-quality appearance.

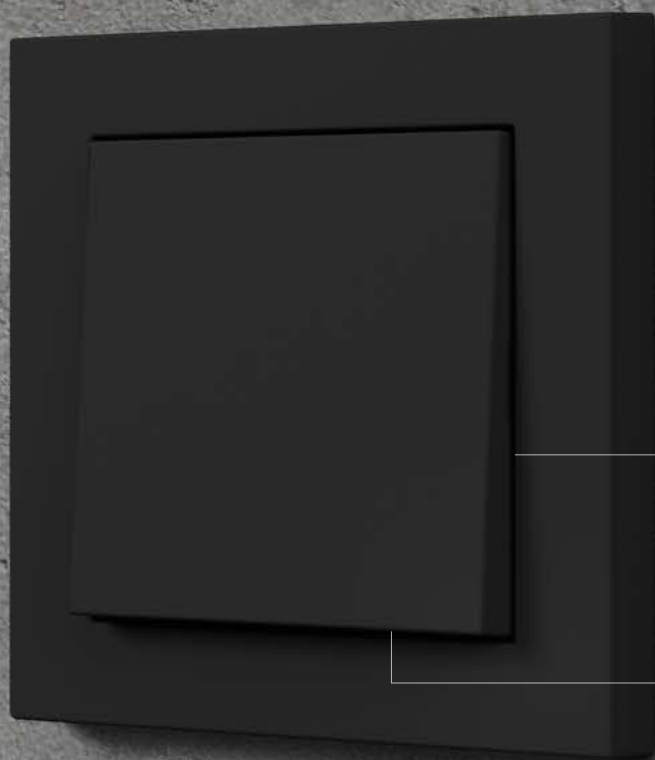

Optimised all-round
gap between rocker
and frame

Very flat switching
angle for optimised
gap between lower
edge of rocker and
frame

Products from the
new switch generation
are available in all
System 55 colour
variants.

- 01 Pure white glossy
- 02 Pure white matt
- 03 Cream white glossy
- 04 Grey matt
- 05 Colour aluminium
- 06 Stainless steel
- 07 Anthracite
- 08 Black matt

01



02

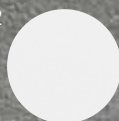

03



04



05



06



07



08



For an integrated, consistent design system, the lighting in the rocker design has been standardised for the 2-way and series switches. The LEDs are available in different colours.

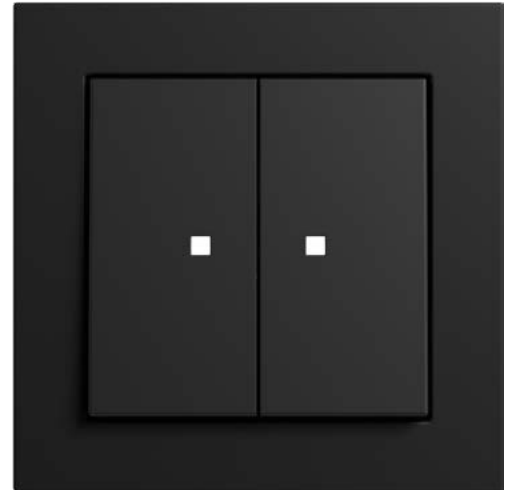
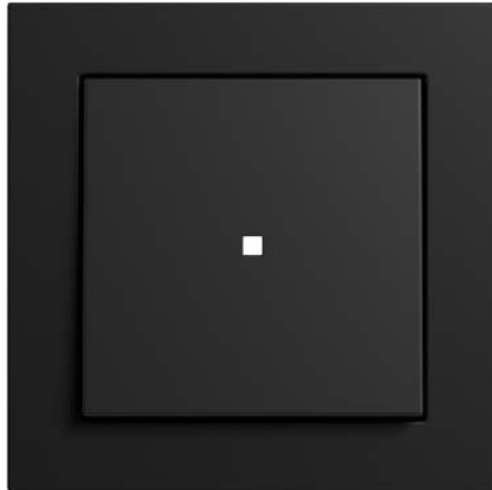

Illustrations:
System 55 rocker switch, 1-gang and 2-gang with control window, black matt; Gira E2 frame, black matt
Item no.
Rocker, 1-gang
3290005
Rocker, 2-gang
3631005
Frame 021109

Available colours

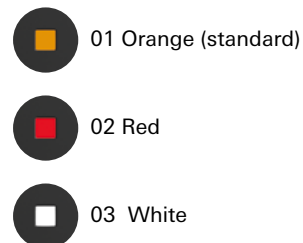

⊕ Highlights, facts and benefits of the new Gira switch generation:

Uniform, all-round gap between rocker and frame.

Pleasant switching sensation due to flatter switching angle for an increased sense of quality.

Floating rocker holder bearing automatically keeps the rocker perfectly centred in the cover frame.

The right rocker for every requirement.

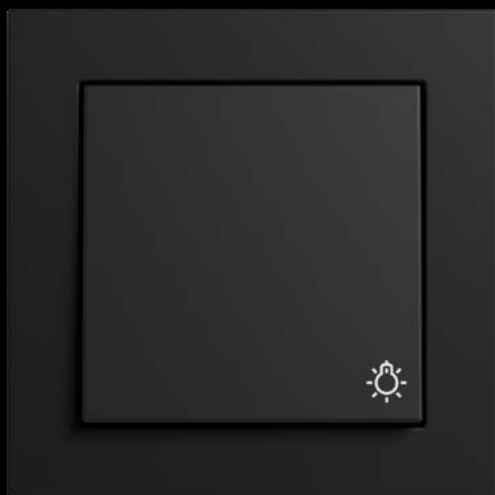

Use of the new standardised Gira symbol system throughout the entire product range.
Item. no.
Rocker 3285005,
Frame 021109

- | | |
|---|---|
| 01 Rocker
Item no. 329603 | 13 Rocker with large
inscription space
Item no. 367600 |
| 02 Rocker with control
window
Item no. 329003 | 14 Rocker with raised
light symbol,
neutral
Item no. 321600 |
| 03 Rocker with
inscription space
Item no. 329903 | 15 Rocker with raised
door symbol,
neutral
Item no. 321800 |
| 04 Rocker with
inscription space
and control
window
Item no. 367003 | 16 Rocker with raised
bell symbol,
neutral
Item no. 321700 |
| 05 Rocker, 2-gang
Item no. 329503 | 17 Rocker with
heating emergency
switch imprint and
control window
Item no. 367803 |
| 06 Rocker, 2-gang
with control
window
Item no. 363103 | 18 Cover for pull-cord
switch with
control window
Item no. 363803 |
| 07 Rocker, 2-gang
with arrow symbols
(blind)
Item no. 329403 | 19 Rocker switch,
10 A for hotel
room status
display with
mounting claws
Item no. 310403 |
| 08 Rocker, 2-gang
with arrow symbols
(blind)
Item no. 329703 | 20 Hotel card button,
1-gang, 1-pole
with separate N
terminal and
mounting claws
Item no. 314003 |
| 09 Rocker with light
symbol
Item no. 328503 | |
| 10 Rocker with bell
symbol and control
window
Item no. 367403 | |
| 11 Rocker with door
symbol
Item no. 328703 | |
| 12 Rocker with bell
symbol and
inscription space
Item no. 367303 | |

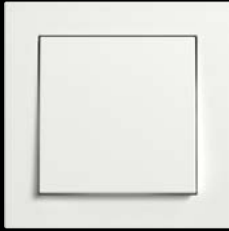

01

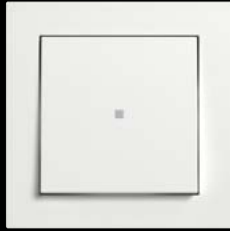

02

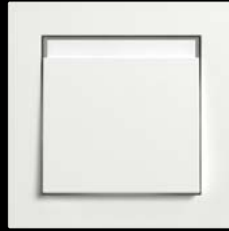

03



04

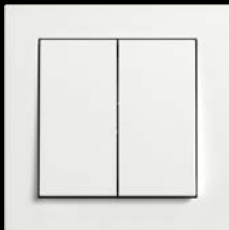

05

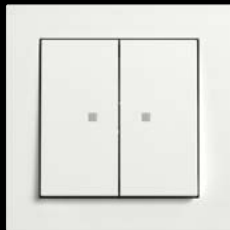

06

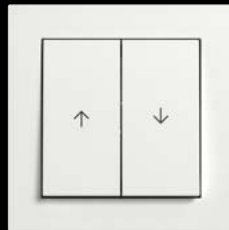

07

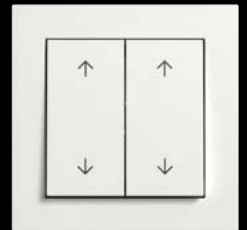

08



09



10

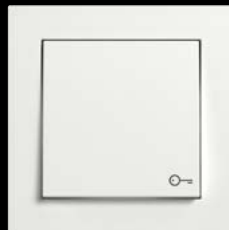

11



12

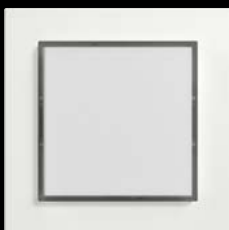

13



14



15



16



17



18

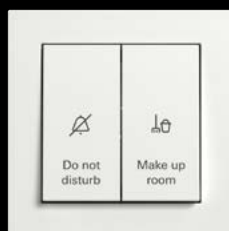

19



20

Optimised
across the
board.



01



02

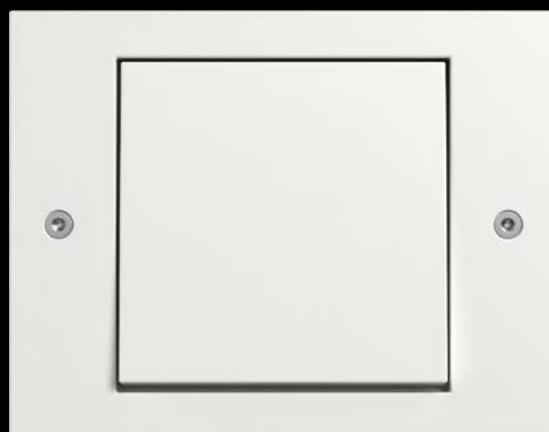

03

More details available
online via the QR code
or at [partner.gira.com/
new_switch_generation](https://partner.gira.com/new_switch_generation)
from 1 February 2024



The new Gira switch generation has updated the entire system: all flush-mounted inserts up to 16 A for Gira System 55, TX_44, Gira F100, surface-mounted and water-protected surface-mounted design lines have been redesigned.



04



05

The illustrations provide examples of the various ranges.

- 01 System 55: Gira E2, pure white glossy
Item no. 329603
- 02 Gira F100 complete device,
pure white glossy
Item no. 329670
- 03 TX_44,
pure white glossy
Item no. 329666
- 04 Surface-mounted dry,
pure white glossy
Item no. 310613
- 05 Water-protected surface-mounted,
grey
Item no. 311630

The entire range at a glance.

Please be sure to note the
new item numbers in good
time when placing your order:

010600	4188 112	012603
310600	4188 70	312600 329603

From now on, item numbers for the individual inserts and rockers will start with a 3 instead of 0.

For Gira F100 switches and socket outlets, item numbers with last digits that were previously 112 will now end in 70.

The previous complete pushbutton switch devices have been discontinued and will be replaced by the new pushbutton switch inserts and standardised new rockers.

All products and delivery date information in the online catalogue at catalogue.gira.com from 1 February 2024

Old/new item number conversion aid available from 1 February 2024:



Flush-mounted / Inserts / Rocker switches

Old item no.	New item no.	Product
010200	310200	Rocker switch, CB, 2-pole, 10 AX, 250 V~ with mounting claws
	381200	Rocker switch, CB, 2-pole, 10 AX, 250 V~ without mounting claws
	317200	Rocker switch, CB, 2-pole, 16 AX, 250 V~ with mounting claws
010500	310500	Rocker switch, 2-gang, 10 AX, 250 V~ with mounting claws
	317500	Rocker switch, 2-gang, 16 AX, 250 V~ with mounting claws
010600	310600	Rocker switch, universal off/2-way, 10 AX, 250 V~ with mounting claws
	317600	Rocker switch, universal off/2-way, 16 AX, 250 V~ with mounting claws
010700	310700	Rocker switch, intermediate, 10 AX, 250 V~ with mounting claws
	381700	Rocker switch, intermediate, 10 AX, 250 V~ without mounting claws
010800	310800	Rocker switch, double 2-way, 10 AX, 250 V~ with mounting claws
	381800	Rocker switch, double 2-way, 10 AX, 250 V~ without mounting claws
010900	310900	Rocker switch, 2-way, 2-pole, 10 AX, 250 V~ with mounting claws
	381900	Rocker switch, 2-way, 2-pole, 10 AX, 250 V~ without mounting claws
011200	311200	Rocker switch, control, CB, 2-pole, 10 AX, 250 V~ with mounting claws
	382200	Rocker switch, control, CB, 2-pole, 10 AX, 250 V~ without mounting claws
	318200	Rocker switch, control, CB, 2-pole, 16 AX, 250 V~ with mounting claws
011600	311600	Rocker switch, control, universal off/2-way, 10 AX, 250 V~ with mounting claws
	382600	Rocker switch, control, universal off/2-way, 10 AX, 250 V~ without mounting claws
	318600	Rocker switch, control, universal off/2-way, 16 AX, 250 V~ with LED element, 230 V with mounting claws
014500	311500	Rocker switch, 2-gang, control, 10 AX, 250 V~ with mounting claws
	382500	Rocker switch, 2-gang, control, 10 AX, 250 V~ without mounting claws
015900	315900	Rocker switch, blind, 10 AX, 250 V~ with mounting claws
	387900	Rocker switch, blind, 10 AX, 250 V~ without mounting claws
081500	381500	Rocker switch, 2-gang, 10 AX, 250 V~ without mounting claws
081600	381600	Rocker switch, universal off/2-way, 10 AX, 250 V~ without mounting claws

Flush-mounted / Inserts / Pushbutton switches

Old item no.	New item no.	Product
0122xx	312200	Pushbutton switch, control, CB, 2-pole, 10 AX, 250 V~ with mounting claws
	384200	Pushbutton switch, control, CB, 2-pole, 10 AX, 250 V~ without mounting claws
0125xx	312500	Pushbutton switch, 2-gang, 10 AX, 250 V~ with mounting claws
	383500	Pushbutton switch, 2-gang, 10 AX, 250 V~ without mounting claws
0126xx	312600	Pushbutton switch, universal off/2-way, 10 AX, 250 V~ with mounting claws
	383600	Pushbutton switch, universal off/2-way, 10 AX, 250 V~ without mounting claws
0127xx	312700	Pushbutton switch, intermediate, 10 AX, 250 V~ with mounting claws
	383700	Pushbutton switch, intermediate, 10 AX, 250 V~ without mounting claws
0128xx	312800	Pushbutton switch, double 2-way, 10 AX, 250 V~ with mounting claws
	383800	Pushbutton switch, double 2-way, 10 AX, 250 V~ without mounting claws
0136xx	313600	Pushbutton switch, control, 10 AX, 250 V~ with mounting claws
0145xx	313500	Pushbutton switch, control, 2-gang, 10 AX, 250 V~ with mounting claws
	384500	Pushbutton switch, control, 2-gang, 10 AX, 250 V~ without mounting claws

xx: The items are available in the different colour variants of the corresponding system.

Flush-mounted / Inserts / Rocker buttons

Old item no.	New item no.	Product
014700	314700	Rocker button, NO contact, 4-gang, 10 AX, 250 V~ with mounting claws
	386700	Rocker button, NO contact, 4-gang, 10 AX, 250 V~ without mounting claws
015000	315000	Rocker button, NO contact with N terminal, 10 AX, 250 V~ with mounting claws
	387000	Rocker button, NO contact with N terminal, 10 AX, 250 V~ without mounting claws
015100	315100	Rocker button, NO contact, 10 AX, 250 V~ with mounting claws
	387100	Rocker button, NO contact, 10 AX, 250 V~ without mounting claws
015200	315200	Rocker button, NO contact, signal contact 10 AX, 250 V~ with mounting claws
	387200	Rocker button, NO contact, signal contact, 10 AX, 250 V~ without mounting claws
015500	315500	Rocker button, 2-way momentary contact, 2-gang, 10 AX, 250 V~ with mounting claws
	387500	Rocker button, 2-way momentary contact, 2-gang, 10 AX, 250 V~ without mounting claws
015600	315600	Rocker button, 2-way momentary contact, 10 AX, 250 V~ with mounting claws
	387600	Rocker button, 2-way momentary contact, 10 AX, 250 V~ without mounting claws
015800	315800	Rocker button, blind, 10 AX, 250 V~ with mounting claws
	387800	Rocker button, blind, 10 AX, 250 V~ without mounting claws

Flush-mounted / Inserts / Rocker switches / Rocker buttons

Old item no.	New item no.	Product
013900	313900	Rocker switch / rocker button, 10 AX, 250 V~ with mounting claws
	386900	Rocker switch / rocker button, 10 AX, 250 V~ without mounting claws

Flush-mounted / Inserts / Pull-cord switches / Pull-cord buttons

Old item no.	New item no.	Product
014200	354200	Pull-cord switch, CB, 2-pole, 10 AX, 250 V~ with mounting claws
014600	354600	Pull-cord switch, universal off/2-way, 10 AX, 250 V~ with mounting claws
016500	356500	Pull-cord button, NO contact, signal contact, 10 AX, 250 V~ with mounting claws
081100	386500	Pull-cord button, NO contact, signal contact, 10 AX, 250 V~ without mounting claws
081800	358200	Pull-cord switch, 2-pole, 10 AX, 250 V~ without mounting claws
081900	358600	Pull-cord switch, universal off/2-way, 10 AX, 250 V~ without mounting claws

Flush-mounted / Inserts / Rockers and covers for rocker switches, rocker buttons and pushbutton switches

Old item no.	New item no.	Product
020901	329101	System 55 rocker with socket outlet symbol and control window, cream white glossy
020903	329103	System 55 rocker with socket outlet symbol and control window, pure white glossy
020926	329126	System 55 rocker with socket outlet symbol and control window, colour aluminium
020927	329127	System 55 rocker with socket outlet symbol and control window, pure white matt
020928	329128	System 55 rocker with socket outlet symbol and control window, anthracite
0209005	3291005	System 55 rocker with socket outlet symbol and control window, black matt
0216xx	321600	System 55 rocker with raised light symbol, neutral
0217xx	321700	System 55 rocker with raised bell symbol, neutral
0218xx	321800	System 55 rocker with raised door symbol, neutral
028501	328501	System 55 rocker with light symbol, cream white glossy
028503	328503	System 55 rocker with light symbol, pure white glossy
028526	328526	System 55 rocker with light symbol, colour aluminium
028527	328527	System 55 rocker with light symbol, pure white matt
028528	328528	System 55 rocker with light symbol, anthracite
0285005	3285005	System 55 rocker with light symbol, black matt
0285015	3285015	System 55 rocker with light symbol, grey matt
0285600	3285600	System 55 rocker with light symbol, stainless steel
028565	328565	TX_44 rocker with light symbol, colour aluminium
028566	328566	TX_44 rocker with light symbol, pure white
028567	328567	TX_44 rocker with light symbol, anthracite
0285112	328570	Gira F100 rocker with light symbol, pure white glossy
028601	328601	System 55 rocker with bell symbol, cream white glossy
028603	328603	System 55 rocker with bell symbol, pure white glossy
028626	328626	System 55 rocker with bell symbol, colour aluminium
028627	328627	System 55 rocker with bell symbol, pure white matt
028628	328628	System 55 rocker with bell symbol, anthracite
0286005	3286005	System 55 rocker with bell symbol, black matt
0286015	3286015	System 55 rocker with bell symbol, grey matt
0286600	3286600	System 55 rocker with bell symbol, stainless steel
028665	328665	TX_44 rocker with bell symbol, colour aluminium
028666	328666	TX_44 rocker with bell symbol, pure white
028667	328667	TX_44 rocker with bell symbol, anthracite
0286112	328670	Gira F100 rocker with bell symbol, pure white glossy
028701	328701	System 55 rocker with door symbol, cream white glossy
028703	328703	System 55 rocker with door symbol, pure white glossy
028726	328726	System 55 rocker with door symbol, colour aluminium
028727	328727	System 55 rocker with door symbol, pure white matt
028728	328728	System 55 rocker with door symbol, anthracite
0287005	3287005	System 55 rocker with door symbol, black matt
0287015	3287015	System 55 rocker with door symbol, grey matt
0287600	3287600	System 55 rocker with door symbol, stainless steel
028765	328765	TX_44 rocker with door symbol, colour aluminium

xx: The items are available in the different colour variants of the corresponding system.

Flush-mounted / Inserts / Rockers and covers for rocker switches, rocker buttons and pushbutton switches

Old item no.	New item no.	Product
028766	328766	TX_44 rocker with door symbol, pure white
028767	328767	TX_44 rocker with door symbol, anthracite
0287112	328770	Gira F100 rocker with door symbol, pure white glossy
029001	329001	System 55 rocker with control window, cream white glossy
029003	329003	System 55 rocker with control window, pure white glossy
029026	329026	System 55 rocker with control window, colour aluminium
029027	329027	System 55 rocker with control window, pure white matt
029028	329028	System 55 rocker with control window, anthracite
0290005	3290005	System 55 rocker with control window, black matt
0290015	3290015	System 55 rocker with control window, grey matt
0290600	3290600	System 55 rocker with control window, stainless steel
029065	329065	TX_44 rocker with control window, colour aluminium
029066	329066	TX_44 rocker with control window, pure white
029067	329067	TX_44 rocker with control window, anthracite
0290112	329070	Gira F100 rocker with control window, pure white glossy
	349003	System 55 upright rocker for rocker buttons and pushbutton switches with control window, pure white glossy
	349026	System 55 upright rocker for rocker buttons and pushbutton switches with control window, colour aluminium
	349027	System 55 upright rocker for rocker buttons and pushbutton switches with control window, pure white matt
	349028	System 55 upright rocker for rocker buttons and pushbutton switches with control window, anthracite
	3490005	System 55 upright rocker for rocker buttons and pushbutton switches with control window, black matt
	349065	TX_44 upright rocker for rocker buttons and pushbutton switches with control window, colour aluminium
	349066	TX_44 upright rocker for rocker buttons and pushbutton switches with control window, pure white
	349067	TX_44 upright rocker for rocker buttons and pushbutton switches with control window, anthracite
029401	329401	System 55 rocker, 2-gang with arrow symbol (blind), cream white glossy
029403	329403	System 55 rocker, 2-gang with arrow symbol (blind), pure white glossy
029426	329426	System 55 rocker, 2-gang with arrow symbol (blind), colour aluminium
029427	329427	System 55 rocker, 2-gang with arrow symbol (blind), pure white matt
029428	329428	System 55 rocker, 2-gang with arrow symbol (blind), anthracite
0294005	3294005	System 55 rocker, 2-gang with arrow symbol (blind), black matt
0294015	3294015	System 55 rocker, 2-gang with arrow symbol (blind), grey matt
0294600	3294600	System 55 rocker, 2-gang with arrow symbol (blind), stainless steel
029465	329465	TX_44 rocker, 2-gang with arrow symbol (blind), colour aluminium
029466	329466	TX_44 rocker, 2-gang with arrow symbol (blind), pure white
029467	329467	TX_44 rocker, 2-gang with arrow symbol (blind), anthracite
0294112	329470	Gira F100 rocker, 2-gang with arrow symbol (blind), pure white glossy
029501	329501	System 55 rocker, 2-gang, cream white glossy
029503	329503	System 55 rocker, 2-gang, pure white glossy
029526	329526	System 55 rocker, 2-gang, colour aluminium
029527	329527	System 55 rocker, 2-gang, pure white matt

Flush-mounted / Inserts / Rockers and covers for rocker switches, rocker buttons and pushbutton switches

Old item no.	New item no.	Product
029528	329528	System 55 rocker, 2-gang, anthracite
0295005	3295005	System 55 rocker, 2-gang, black matt
0295015	3295015	System 55 rocker, 2-gang, grey matt
0295600	3295600	System 55 rocker, 2-gang, stainless steel
029565	329565	TX_44 rocker 2-gang, colour aluminium
029566	329566	TX_44 rocker, 2-gang, pure white
029567	329567	TX_44 rocker, 2-gang, anthracite
0295112	329570	Gira F100 rocker, 2-gang, pure white glossy
	349503	System 55 upright rocker, 2-gang for rocker buttons and pushbutton switches, pure white glossy
	349526	System 55 upright rocker, 2-gang for rocker buttons and pushbutton switches, colour aluminium
	349527	System 55 upright rocker, 2-gang for rocker buttons and pushbutton switches, pure white matt
	349528	System 55 upright rocker, 2-gang for rocker buttons and pushbutton switches, anthracite
	3495005	System 55 upright rocker, 2-gang for rocker buttons and pushbutton switches, black matt
	3495015	System 55 upright rocker, 2-gang for rocker buttons and pushbutton switches, grey matt
	3495600	System 55 upright rocker, 2-gang for rocker buttons and pushbutton switches, stainless steel
	349565	TX_44 upright rocker, 2-gang for rocker buttons and pushbutton switches, colour aluminium
	349566	TX_44 upright rocker, 2-gang for rocker buttons and pushbutton switches, pure white
	349567	TX_44 upright rocker, 2-gang for rocker buttons and pushbutton switches, anthracite
029601	329601	System 55 rocker, cream white glossy
029603	329603	System 55 rocker, pure white glossy
029626	329626	System 55 rocker, colour aluminium
029627	329627	System 55 rocker, pure white matt
029628	329628	System 55 rocker, anthracite
0296005	3296005	System 55 rocker, black matt
0296015	3296015	System 55 rocker, grey matt
0296600	3296600	System 55 rocker, stainless steel
029665	329665	TX_44 rocker, colour aluminium
029666	329666	TX_44 rocker, pure white
029667	329667	TX_44 rocker, anthracite
296112	329670	Gira F100 rocker, pure white glossy
	349603	System 55 upright rocker for rocker buttons and pushbutton switches, pure white glossy
	349626	System 55 upright rocker for rocker buttons and pushbutton switches, colour aluminium
	349627	System 55 upright rocker for rocker buttons and pushbutton switches, pure white matt
	349628	System 55 upright rocker for rocker buttons and pushbutton switches, anthracite
	3496005	System 55 upright rocker for rocker buttons and pushbutton switches, black matt
	3496015	System 55 upright rocker for rocker buttons and pushbutton switches, grey matt
	3496600	System 55 upright rocker for rocker buttons and pushbutton switches, stainless steel
	349665	TX_44 upright rocker for rocker buttons and pushbutton switches, colour aluminium
	349666	TX_44 upright rocker for rocker buttons and pushbutton switches, pure white
	349667	TX_44 upright rocker for rocker buttons and pushbutton switches, anthracite
029901	329901	System 55 rocker with inscription space, cream white glossy
029903	329903	System 55 rocker with inscription space, pure white glossy

Flush-mounted / Inserts / Rockers and covers for rocker switches, rocker buttons and pushbutton switches

Old item no.	New item no.	Product
029926	329926	System 55 rocker with inscription space, colour aluminium
029927	329927	System 55 rocker with inscription space, pure white matt
029928	329928	System 55 rocker with inscription space, anthracite
0299005	3299005	System 55 rocker with inscription space, black matt
0299015	3299015	System 55 rocker with inscription space, grey matt
0299600	3299600	System 55 rocker with inscription space, stainless steel
	367600	System 55 rocker with large inscription space (full-surface), neutral
	367000	Gira F100 rocker with large inscription space (full-surface), neutral
063101	363101	System 55 rocker, 2-gang with control window, cream white glossy
063103	363103	System 55 rocker, 2-gang with control window, pure white glossy
063126	363126	System 55 rocker, 2-gang with control window, colour aluminium
063127	363127	System 55 rocker, 2-gang with control window, pure white matt
063128	363128	System 55 rocker, 2-gang with control window, anthracite
0631005	3631005	System 55 rocker, 2-gang with control window, black matt
0631015	3631015	System 55 rocker, 2-gang with control window, grey matt
	363170	Gira F100 rocker, 2-gang with control window, pure white glossy
063801	363801	System 55 cover for pull-cord switch with control window, cream white glossy
063803	363803	System 55 cover for pull-cord switch with control window, pure white glossy
063827	363827	System 55 cover for pull-cord switch with control window, pure white matt
063828	363828	System 55 cover for pull-cord switch with control window, anthracite
0638005	3638005	System 55 cover for pull-cord switch with control window, black matt
063801	363901	System 55 cover for pull-cord button with control window, cream white glossy
063803	363903	System 55 cover for pull-cord button with control window, pure white glossy
067001	367001	System 55 rocker with inscription space and control window, cream white glossy
067003	367003	System 55 rocker with inscription space and control window, pure white glossy
067026	367026	System 55 rocker with inscription space and control window, colour aluminium
067027	367027	System 55 rocker with inscription space and control window, pure white matt
067028	367028	System 55 rocker with inscription space and control window, anthracite
0670005	3670005	System 55 rocker with inscription space and control window, black matt
0670015	3670015	System 55 rocker with inscription space and control window, grey matt
067301	367301	System 55 rocker with bell symbol and inscription space, cream white glossy
067303	367303	System 55 rocker with bell symbol and inscription space, pure white glossy
067326	367326	System 55 rocker with bell symbol and inscription space, colour aluminium
067327	367327	System 55 rocker with bell symbol and inscription space, pure white matt
067328	367328	System 55 rocker with bell symbol and inscription space, anthracite
0673005	3673005	System 55 rocker with bell symbol and inscription space, black matt
0673015	3673015	System 55 rocker with bell symbol and inscription space, grey matt
067365	367365	TX_44 rocker with bell symbol and inscription space, colour aluminium
067366	367366	TX_44 rocker with bell symbol and inscription space, pure white
067367	367367	TX_44 rocker with bell symbol and inscription space, anthracite
067401	367401	System 55 rocker with bell symbol and control window, cream white glossy
067403	367403	System 55 rocker with bell symbol and control window, pure white glossy

Flush-mounted / Inserts / Rockers and covers for rocker switches, rocker buttons and pushbutton switches

Old item no.	New item no.	Product
067426	367426	System 55 rocker with bell symbol and control window, colour aluminium
067427	367427	System 55 rocker with bell symbol and control window, pure white matt
067428	367428	System 55 rocker with bell symbol and control window, anthracite
0674005	3674005	System 55 rocker with bell symbol and control window, black matt
0674015	3674015	System 55 rocker with bell symbol and control window, grey matt
	367470	Gira F100 rocker with bell symbol and control window, pure white glossy
067601	367600	System 55 rocker with large inscription space and pushbutton switch, neutral
067665	329965	System 55 rocker with inscription space, colour aluminium
067666	329966	System 55 rocker with inscription space, pure white
067667	329967	System 55 rocker with inscription space, anthracite
	329970	Gira F100 rocker with inscription space, pure white glossy
	367370	Gira F100 rocker with bell symbol and inscription space, pure white glossy
067801	367801	System 55 rocker with heating emergency switch imprint and control window, cream white glossy
067803	367803	System 55 rocker with heating emergency switch imprint and control window, pure white glossy
067826	367826	System 55 rocker with heating emergency switch imprint and control window, colour aluminium
067827	367827	System 55 rocker with heating emergency switch imprint and control window, pure white matt
067828	367828	System 55 rocker with heating emergency switch imprint and control window, anthracite
0678005	3678005	System 55 rocker with heating emergency switch imprint and control window, black matt
067903	367900	System 55 rocker with bell symbol and large inscription space for rocker button, neutral
115001	329701	System 55 rocker, 2-gang with arrow symbol (blind), cream white glossy
115003	329703	System 55 rocker, 2-gang with arrow symbol (blind), pure white glossy
115026	329726	System 55 rocker, 2-gang with arrow symbol (blind), colour aluminium
115027	329727	System 55 rocker, 2-gang with arrow symbol (blind), pure white matt
115028	329728	System 55 rocker, 2-gang with arrow symbol (blind), anthracite
1150005	3297005	System 55 rocker, 2-gang with arrow symbol (blind), black matt
1150015	3297015	System 55 rocker, 2-gang with arrow symbol (blind), grey matt
1150112	329770	Gira F100 rocker, 2-gang with arrow symbol (blind), pure white glossy

Flush-mounted / Inserts / Hotel card buttons / Hotel switch status display

Old item no.	New item no.	Product
014001	314001	System 55 hotel card button, 1-gang, 1-pole with separate N terminal with mounting claws, cream white glossy
014003	314003	System 55 hotel card button, 1-gang, 1-pole with separate N terminal with mounting claws, pure white glossy
014026	314026	System 55 hotel card button, 1-gang, 1-pole with separate N terminal with mounting claws, colour aluminium
014027	314027	System 55 hotel card button, 1-gang, 1-pole with separate N terminal with mounting claws, pure white matt
014028	314028	System 55 hotel card button, 1-gang, 1-pole with separate N terminal with mounting claws, anthracite
0140005	3140005	System 55 hotel card button, 1-gang, 1-pole with separate N terminal with mounting claws, black matt
0140015	3140015	System 55 hotel card button, 1-gang, 1-pole with separate N terminal with mounting claws, grey matt
0140600	3140600	System 55 hotel card button, 1-gang, 1-pole with separate N terminal with mounting claws, stainless steel
0140112	314070	Gira F100 hotel card button, 1-gang, 1-pole with separate N terminal with mounting claws, pure white glossy
110401	310401	System 55 rocker switch, 10 A, for hotel room status display with mounting claws, cream white glossy
110403	310403	System 55 rocker switch, 10 A, for hotel room status display with mounting claws, pure white glossy
110426	310426	System 55 rocker switch, 10 A, for hotel room status display with mounting claws, colour aluminium
110427	310427	System 55 rocker switch, 10 A, for hotel room status display with mounting claws, pure white matt
110428	310428	System 55 rocker switch, 10 A, for hotel room status display with mounting claws, anthracite
1104005	3104005	System 55 rocker switch, 10 A, for hotel room status display with mounting claws, black matt

Flush-mounted / Inserts / Accessories

Old item no.	New item no.	Product
025127	325400	System 55 sealing kit IP44, universal for rocker switches, rocker buttons and pushbutton switches
	325500	System 55 sealing kit IP44, illuminated for rocker switches, rocker buttons and pushbutton switches
049810	399100	Extension claw for switches and socket outlets
2790111	325100	Gira F100 sealing kit IP44 for rocker switches, rocker buttons and pushbutton switches
	3791010	LED element 1 with 230 V, 0.5 mA, white
	3791011	LED element 1 with 230 V, 0.5 mA, red
	3791012	LED element 1 with 230 V, 0.5 mA, orange
	3792010	LED element 2 with 230 V, 0.5 mA, white
	3792011	LED element 2 with 230 V, 0.5 mA, red
	3792012	LED element 2 with 230 V, 0.5 mA, orange
	3793010	LED element 3 with 230 V, 0.5 mA, white/series switch
	3793011	LED element 3 with 230 V, 0.5 mA, red/series switch
	3793012	LED element 3 with 230 V, 0.5 mA, orange/series switch
	3794010	LED element 4 with 12–30 V, 0.5 mA, white
	3794011	LED element 4 with 12–30 V, 0.5 mA, red
	3794012	LED element 4 with 12–30 V, 0.5 mA, orange
	3795010	LED element 5 with 12–30 V, 0.5 mA, white
	3795011	LED element 5 with 12–30 V, 0.5 mA, red
	3795012	LED element 5 with 12–30 V, 0.5 mA, orange

Water-protected surface-mounted IP44 / Rocker switches

Old item no.	New item no.	Product
010230	310230	rocker switch, CB, 2-pole, 10 A, 250 V~, grey
	318230	rocker switch, control, CB, 2-pole with inscription space, 16 A, 250 V~, grey
010530	310530	rocker switch, 2-gang, 10 A, 250 V~, grey
010630	310630	rocker switch, universal off/2-way, 10 A, 250 V~, grey
	318630	rocker switch, control, universal off/2-way, with inscription space, 16 A, 250 V~ grey
010730	310730	rocker switch, intermediate, 10 A, 250 V~, grey
011230	311230	rocker switch, control, CB, 2-pole with inscription space, 10 A, 250 V~, grey
011630	311630	rocker switch, control, universal off/2-way, with inscription space, 10 A, 250 V~, grey
020630	320630	cover plate with inscription space and glass pane suitable for water-protected rocker switches, indicator switches and buttons

Water-protected surface-mounted IP44 / Rocker buttons

Old item no.	New item no.	Product
015230	315230	rocker button, NO contact, 1-pole with signal contact, 10 A, 250 V~, grey
015530	315330	rocker button, 2-gang, 10 A, 250 V~, grey
015630	315630	rocker button, 2-way, 1-pole, 10 A, 250 V~, grey

Water-protected surface-mounted IP44 / Combinations

Old item no.	New item no.	Product
417630	417630	combination of rocker switch, universal off/2-way / SCHUKO socket outlet with vertical hinged cover, grey
417730	417730	combination of rocker switch, universal off/2-way / SCHUKO socket outlet with horizontal hinged cover, grey
015231	315231	rocker button, NO contact, 1-pole, 10 AX, 250 V~ with inscription space with separate signal contact, grey
015631	315631	rocker button, 2-way, 1-pole, 10 AX, 250 V~ with inscription space

Surface-mounted / Rocker switches

Old item no.	New item no.	Product
010513	310513	rocker switch, 2-gang, 10 A, 250 V~, pure white glossy
010613	310613	rocker switch, universal off/2-way, 10 A, 250 V~, pure white glossy
011210	311210	rocker switch, control, CB, 2-pole, 10 A, 250 V~ K/P, cream white glossy
011613	311613	rocker switch, control, universal off/2-way, 10 A, 250 V~, pure white glossy
015913	315913	rocker switch, blind, 10 A, 250 V~, pure white glossy

Surface-mounted / Rocker buttons

Old item no.	New item no.	Product
015210	315210	rocker button, NO contact with separate signal contact, 10 A, 250 V~ K/P, cream white glossy
015613	315613	rocker button, 2-way, 10 A, 250 V~, pure white glossy
015813	315813	rocker button, blind, 10 A, 250 V~, pure white glossy

Surface-mounted / Pull-cord switches

Old item no.	New item no.	Product
014613	314613	pull-cord switch, universal off/2-way, 10 A, 250 V~, pure white glossy

Surface-mounted / Socket outlets

Old item no.	New item no.	Product
044013	444013	SCHUKO socket outlet, 16 A, 250 V~, pure white glossy
047014	447014	socket outlet without protective contact, 16 A, 250 V~, pure white glossy
078013	478013	SCHUKO socket outlet, 2-gang, 16 A, 250 V~, pure white glossy
078018	478018	SCHUKO socket outlet, 2-gang, 16 A, 250 V~, brown glossy
078019	478019	SCHUKO socket outlet, 2-gang, 16 A, 250 V~, grey glossy
078913	478913	SCHUKO socket outlet, 3-gang, 16 A, 250 V~, pure white glossy

Surface-mounted / Combinations of switches / socket outlets

Old item no.	New item no.	Product
017613	417613	combination of rocker switch, universal off/2-way / SCHUKO socket outlet vertical, pure white glossy

Surface-mounted / Accessories

Old item no.	New item no.	Product
	305010	EZ-TH mounting plate, 2-gang, K/P, cream white glossy
	305011	EZ-TH mounting plate, 2-gang, K/P, pure white glossy
	305014	EZ-TH mounting plate, 2-gang, pure white glossy
	305110	EZ-TH mounting plate, 1-gang, for socket outlets, K/P, cream white glossy
	305111	EZ-TH mounting plate, 1-gang, for socket outlets, K/P, pure white glossy
	305114	EZ-TH mounting plate, 1-gang, pure white glossy
	305210	EZ-TH mounting plate, 2-gang, for combination of switch / SCHUKO socket outlet, K/P, cream white glossy
	305211	EZ-TH mounting plate, 2-gang, K/P, pure white glossy
	305214	EZ-TH mounting plate, 2-gang, pure white glossy
	305310	EZ-TH mounting plate, 3-gang, K/P, cream white glossy
	305311	EZ-TH mounting plate, 3-gang, K/P, pure white glossy
	305314	EZ-TH mounting plate, 3-gang, pure white glossy
	305510	EZ-TH mounting plate, 3-gang, K/P, cream white glossy
	305511	EZ-TH mounting plate, 3-gang, K/P, pure white glossy
	305610	EZ-TH mounting plate, 1-gang, for switches, K/P, cream white glossy
	305611	EZ-TH mounting plate, 1-gang, for switches, K/P, pure white glossy
	305910	EZ-TH mounting plate, 2-gang, for combination of switch / SCHUKO socket outlet without protective contact, K/P, cream white glossy
	305911	EZ-TH mounting plate, 2-gang, for combination of switch / SCHUKO socket outlet without protective contact, K/P, pure white glossy
008410	888410	Mounting cross/metal adapter

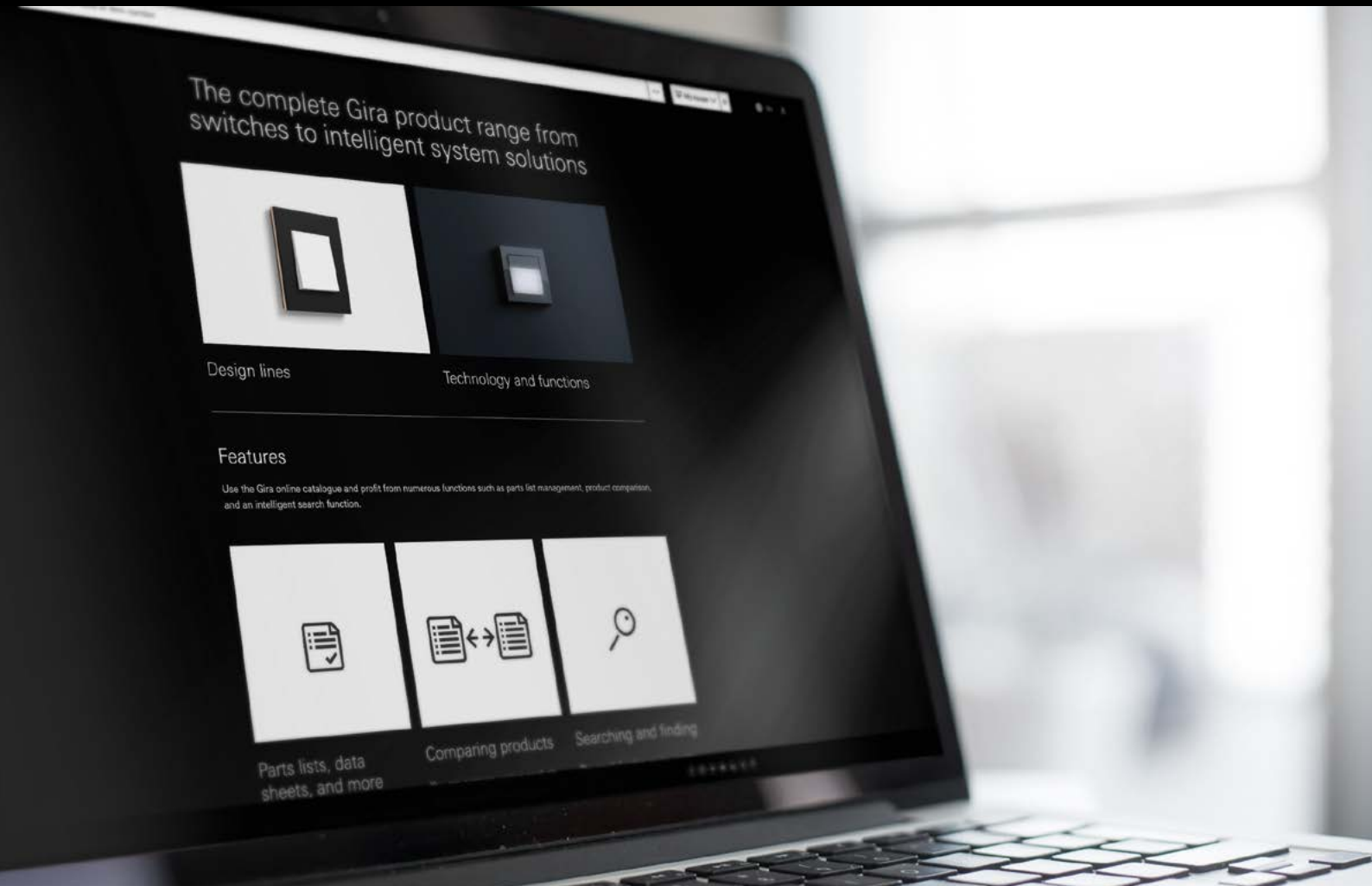

The online catalogue. Always up-to-date.

Discover the complete Gira product range from switches to intelligent system solutions. The Gira online catalogue offers you a host of useful features: you can compare products, use the intelligent search function, manage parts lists and transfer them directly to your shopping cart at many wholesalers via the Elbridge interface.

All products and delivery date information in the online catalogue at catalogue.gira.com from 1 February 2024

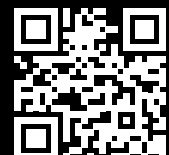

Being innovative means thinking beyond your own four walls.

Since 1905, we've been the ones with the switches, but we're so much more ... Because innovation is our great passion. Our pioneering spirit drives us to constantly improve and enhance the comfort of people's homes with innovative solutions.

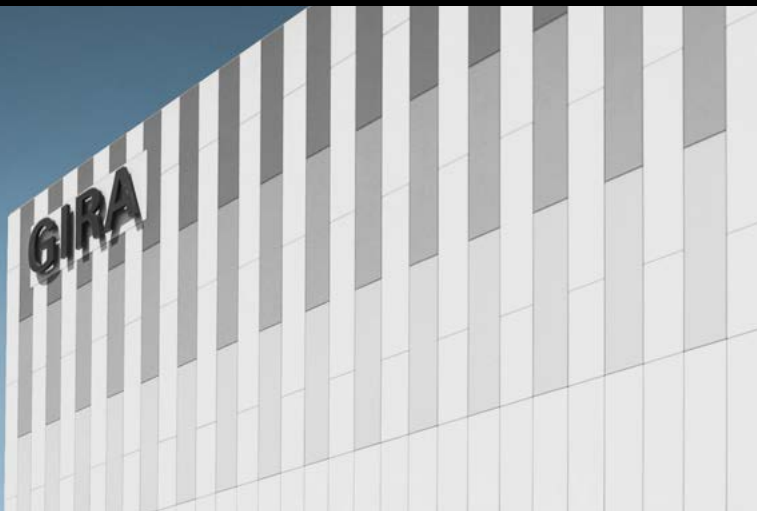

"Made by Diversity".

Gira has been manufacturing products at its location in Radevormwald for more than 100 years. The company is fully committed to the "Made in Germany" quality standard. This is what 1,250 employees from 27 nations work for – each and every one of them with different talents, individual expertise, wide-ranging experiences and different life stories. This diversity – supported by shared values – provides the basis for our creativity, innovative strength and future viability.

Innovative technology,
award-winning design.

We have always aspired to combine maximum functionality and reliability with a unique design to create special user experiences. The extraordinary design quality and functionality of our products have been recognised by many internationally acclaimed awards.



Published by:
Gira Giersiepen GmbH & Co. KG

Picture credits:
Icons: pages 12 & 13
schmitz Visuelle Kommunikation
hgschmitz.de

Subject to technical modifications.

Graphics in this brochure show basic correlations and do not claim to be technically exhaustive. Products may be shown with special inscription. Subject to technical modifications.

Any colour variations between the images in this product information and the product are due to printing processes and cannot be avoided.

Shaping the future also means doing everything possible to protect the environment in which we want to live in the future. When creating this brochure, Gira supports the idea of sustainability by handling resources responsibly and using environmentally sound materials. The paper used is FSC® certified and made of at least 60% recycled paper.

sustainability.gira.com



GIRA

Gira
Giersiepen GmbH & Co. KG

Dahlienstraße
42477 Radevormwald

P.O. Box 12 20
42461 Radevormwald
Germany

Phone +49 2195 602-0
Fax +49 2195 602-119

www.gira.com
info@gira.com

Order no. 18229 90 01/24