

Issue:
11.04.2017
21143200

Heating actuator basic, 6-gang Order No. 2114 00



Table of Contents

1	Product definition	3
1.1	Product catalogue	3
1.2	Function	3
2	Installation, electrical connection and operation	4
2.1	Safety instructions	4
2.2	Device components	5
2.3	Fitting and electrical connection	6
2.4	Commissioning	10
3	Technical data	11
4	Software description	12
4.1	Software specification	12
4.2	Software "Heating actuator basic 6-gang 20D11x"	13
4.2.1	Scope of functions	13
4.2.2	Notes on software	14
4.2.3	Object table	15
4.2.4	Functional description	18
4.2.4.1	Description of channel-independent functions	18
4.2.4.1.1	Priorities	18
4.2.4.1.2	Pump control	19
4.2.4.2	Channel-oriented functional description	21
4.2.4.2.1	Valve direction of action	21
4.2.4.2.2	Reset behaviour	22
4.2.4.2.3	Data formats for command values	23
4.2.4.2.4	Cycle time	28
4.2.4.2.5	Cyclical command value monitoring / emergency operation	31
4.2.4.2.6	Short-circuit and overload detection	33
4.2.4.2.7	Valve rinsing	39
4.2.4.3	Delivery state	43
4.2.5	Parameters	44
5	Appendix	53
5.1	Index	53

1 Product definition

1.1 Product catalogue

Product name: Heating actuator basic, 6-gang

Use: Actuator

Design: RMD (rail-mounted device)

Order No. 2114 00

1.2 Function

The heating actuator is used for the activation of electrothermal actuators (ETA) for heating or cooling systems. It possesses 6 electronic outputs, each of which can silently activate up to 4 (AC 230 V) or 2 (AC 24 V) actuators. Both deenergised closed and deenergised opened actuators can be connected.

The heating actuator receives 1-bit or 1-byte command value telegrams, transmitted, for example, by KNX room temperature controllers. The actuator controls its valve outputs either in switching form or with a PWM signal, according to the data format of the command values and the configuration in the ETS. The cycle time for constant PWM output signals can be configured separately for each valve output of the heating actuator. This allows individual adaptation to different actuator types.

The heating actuator allows switching activation of the circulation pump of the heating or cooling circuit via a 1-bit KNX telegram. When using pump control, the pump is only switched on by the actuator when at least one command value of the outputs exceeds a preset limiting value with hysteresis. The pump is switched off when the limiting value is reached or undershot again. This saves electrical energy, as the pump is only activated by sufficiently large, and thus effective, command values.

To prevent calcification or sticking of a valve which has not been activated for some time, the actuator has an automatic valve rinsing function. Valve rinsing can be executed cyclically or using a bus command, causing the activated valves to run through the full valve stroke for a preset period of time. If necessary, the intelligent valve rinsing can be enabled. In so doing, cyclical rinsing using the full stroke is only executed when a defined minimum command value limiting value was not exceeded during actuator operation.

Cyclical monitoring of the command values can be performed as an option. If, during active cyclical monitoring, there are no command value telegrams during a preset time, then emergency operation is activated for the affected valve output, for which a configurable constant PWM command value can be preset.

The actuator is able to detect an overload or a short-circuit at the valve outputs and, in consequence, to protect them against destruction. Outputs which have experienced a short-circuit or a constant load are deactivated after an identification period. In this case, a short-circuit or overload signal can be transmitted via a KNX communication object.

The device is designed for mounting on DIN rails in closed compact boxes or in distributors in fixed installations in dry interior rooms.

i We recommend using electrothermal actuators of make Gira or, alternatively, models of make Möhlenhoff (AA2004, AA4004) or Sauter (MTX). Always observe the technical data of the actuators and compare them with the technical properties of the heating actuator.

2 Installation, electrical connection and operation

2.1 Safety instructions



Electrical devices may only be mounted and connected by electrically skilled persons.

Failure to observe the instructions may cause damage to the device and result in fire and other hazards.

Danger of electric shock. Device is not suitable for disconnection from supply voltage. The load is not electrically isolated from the mains even when the device is switched off.

Danger of electric shock. Always disconnect before carrying out work on the device or load. At the same time, take into account all circuit breakers that supply dangerous voltage to the device or load.

Make sure during the installation that there is always sufficient insulation between the mains voltage and the bus. A minimum distance of at least 4 mm must be maintained between bus conductors and mains voltage cores.

The device may not be opened or operated outside the technical specifications.

2.2 Device components

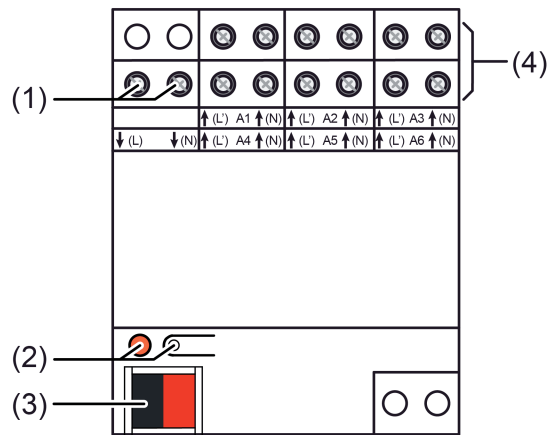

Figure 1: Device components

- (1) Connection for the supply of electrothermal actuators (AC 230 V or AC 24 V)
- (2) Programming button and LEDs
- (3) KNX connection
- (4) Connections for electrothermal actuators

2.3 Fitting and electrical connection



DANGER!

Electrical shock when live parts are touched.

Electrical shocks can be fatal.

Before working on the device, disconnect the power supply and cover up live parts in the working environment.

Fitting the device

- Snap onto a suitable DIN rail. The screw terminals of the valve outputs should be at the top.
- i** A KNX data rail is not required.
- i** Observe the temperature range (see Technical Data) and ensure sufficient cooling, if necessary.

Connect the device for AC 230 V actuators

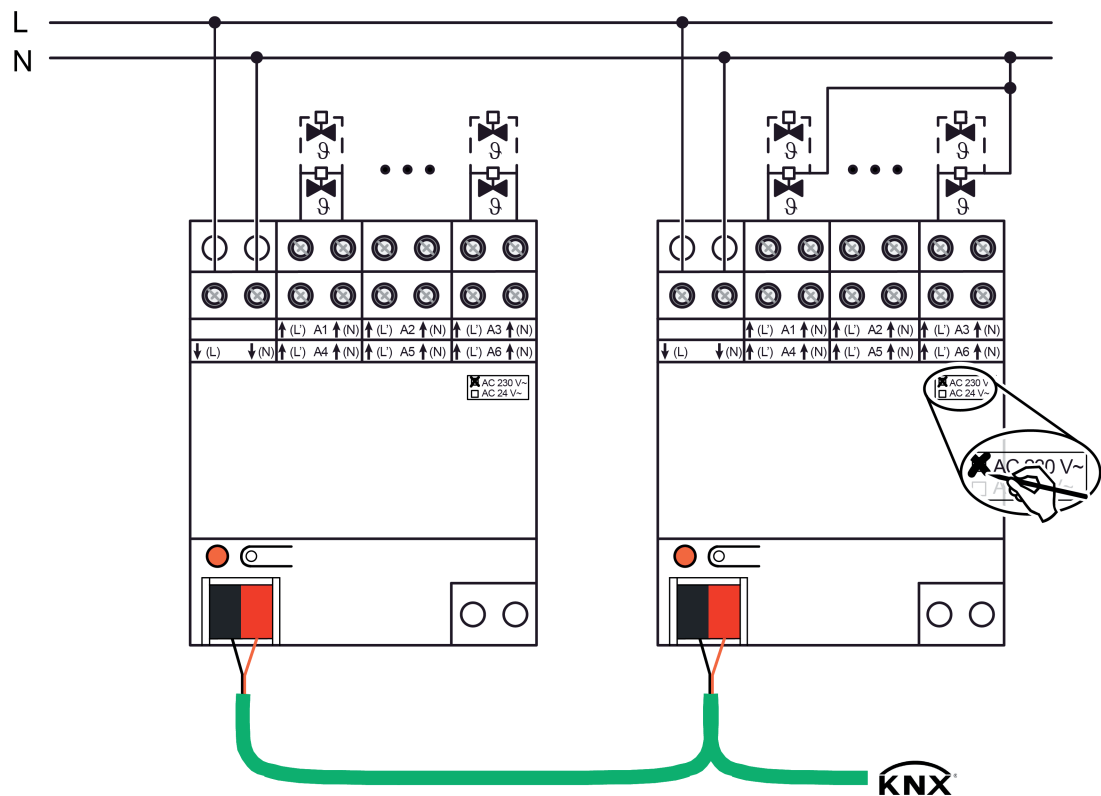

Figure 2: Connection for AC 230 V actuators (connection examples)
 Left: Neutral conductor of the actuators run separately to the actuator /
 Right: Shared neutral conductor for actuators

Only connect AC 230 V actuators to all the outputs.

Only connect actuators with the same characteristics to each output (deenergised closed/opened).

Do not connect unsuitable loads (incandescent lamps, motorised actuators, signal devices, etc.).

If possible, connect actuators for environments with increased fail-safety requirements to the outputs A1 and A4. During overload detection, these are switched off last.

Do not exceed the maximum number of "4" actuators per output.

Observe the technical data of the valve drives used.

- Connect the AC 230 V valve drives according to the connection diagram (Figure 2). The neutral conductors of the actuators can either be connected directly to the N terminals of the outputs of the heating actuator (left-hand connection example) or, alternatively, jointly with a suitable N potential (e.g. N conductor terminal in the distributor) (right-hand connection example). It is not absolutely necessary to connect the neutral conductor of the actuators directly to the actuator.
- ⓘ The neutral conductor terminals of the valve outputs are bridged internally in the device. Do not connect the neutral conductor from the output terminals through to additional devices in the distribution board or to other consumers. Only use the neutral conductor terminals of the outputs for the connections of the actuators of an actuator.
- Connect the supply (mains voltage AC 230 V) for the actuators to the terminals ↓(L) and ↓(N) (1).
- ⓘ Do not connect direct current.
- On the device label, note the type of supply "AC 230 V" with a permanent marker.
- Connect bus line with connecting terminal.

Connect the device for AC 24 V actuators

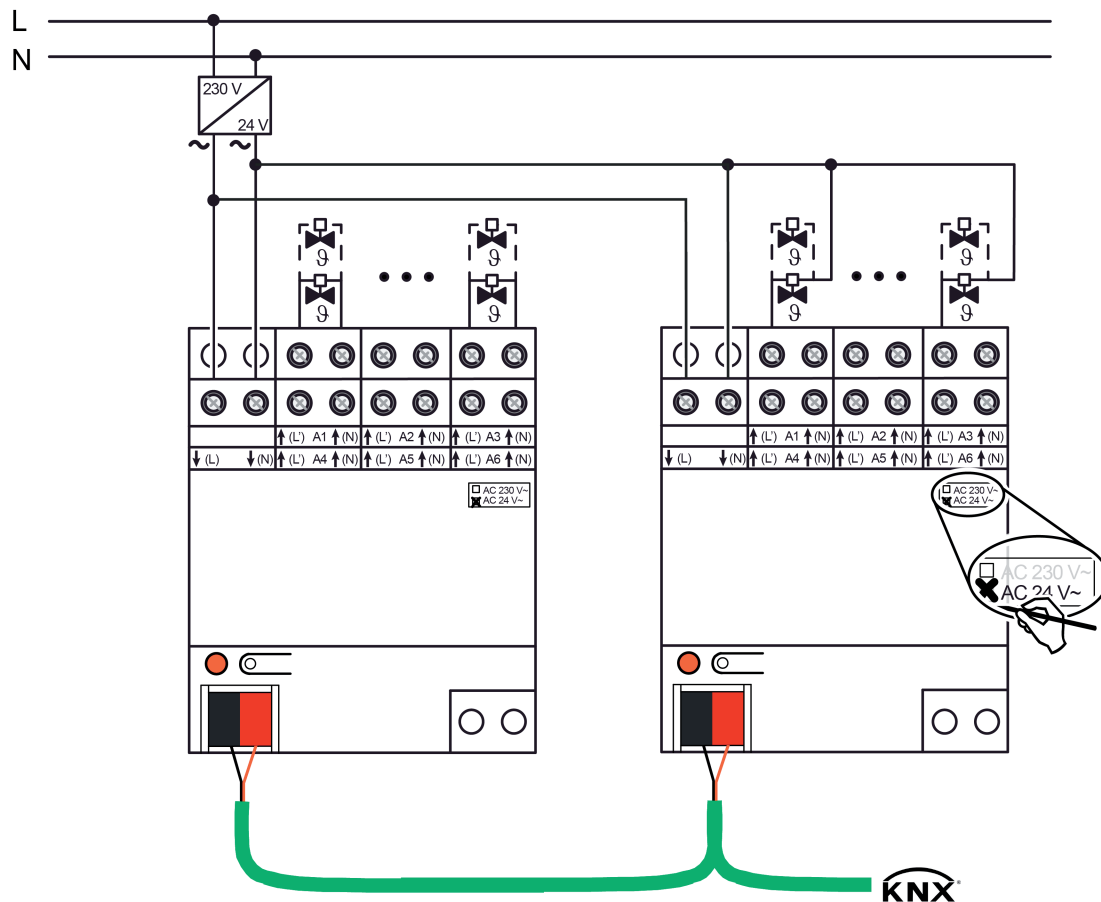

Figure 3: Connection for actuators AC 24 V
 Left: Isolated connection of the actuators, separately on the actuator /
 Right: Shared conductor for actuators

Only connect AC 24 V actuators to all the outputs.

Only connect actuators with the same characteristics to each output (deenergised closed/opened).

Do not connect unsuitable loads (incandescent lamps, motorised actuators, signal devices, etc.).

If possible, connect actuators for environments with increased fail-safety requirements to the outputs A1 and A4. During overload detection, these are switched off last.

Do not exceed the maximum number of "2" actuators per output.

Observe the technical data of the valve drives used.

- Connect the AC 24 V valve drives according to the connection diagram (Figure 3). It is possible to connect the actuators individually and directly with the terminals of the outputs of the heating actuator (left-hand connection example) or, alternatively, using a shared conductor (right-hand connection example).
- i** The terminals of the valve outputs indicated with "(N)" are bridged internally in the device. The terminals may only be used for the connection of the actuators of an actuator. Never connect N potential (mains voltage)!
- Connect the supply for the actuators (AC 24 V) to the terminals ↓(L) and ↓(N) (1). In so doing, use a low voltage AC 24 V from a suitable power supply (transformer, mains power supply).
- i** Do not connect direct current.

- On the device label, note the type of supply "AC 24 V" with a permanent marker.
- Connect bus line with connecting terminal.

2.4 Commissioning

After mounting of the actuator and connection of the bus line, the power supply of the valve drives and of all electrical loads, the device can be put into operation. The following procedure is generally recommended...

Commissioning with the ETS



DANGER!

Electrical shock when live parts are touched.

Electrical shocks can be fatal.

Before working on the device, disconnect the power supply and cover up live parts in the working environment.

- Switch on the bus voltage. Make sure that the bus voltage is available interruption free during the commissioning.
Check: When the programming button is pressed, the red programming LED must light up.
- Configure and program the physical address with the help of the ETS.
- Download the application data with the ETS.
The device is ready for operation.

3 Technical data

General

Ambient temperature	-5 ... +45 °C
Storage/transport temperature	-25 ... +70 °C
Fitting width	72 mm / 4 modules
Test mark	KNX / EIB / VDE
Power loss	max. 1 W

KNX supply

KNX medium	TP 256
Commissioning mode	S-mode
Rated voltage KNX	DC 21 ... 32 V SELV
Current consumption KNX	4 ... 12 mA

Power supply of valve outputs AC 230 V

Rated voltage	AC 230 V ~
---------------	------------

Power supply of valve outputs AC 24 V

Rated voltage	AC 24 V ~
---------------	-----------

Valve outputs

Contact type	Semi-conductor (Triac), ε
Switching voltage	AC 24 / 230 V ~
Switching current	5 ... 160 mA
Switch-on current	max. 1.5 A (2 sec)
Switch-off current	max. 0.3 A (2 min)
Number of drives per output	
230 V drives	max. 4
24 V drives	max. 2

Connections

Connection mode	Screw terminal
Connection type for bus	device connection terminal
single stranded	0.5 ... 4 mm ²
Finely stranded without conductor sleeve	0.5 ... 4 mm ²
Finely stranded with conductor sleeve	0.5 ... 2.5 mm ²

4 Software description

4.1 Software specification

ETS search paths: heating, air condition / valves / Heating actuator basic, 6-gang

Applications:

No.	Short description	Name	Version	from mask version
1	Multifunctional heating actuator application: Activation of up to 6 valve outputs for electrothermal actuators by 1-bit command values.	Heating actuator basic 6-gang 20D111	1.1 for ETS3.0, Version d onwards, ETS4 Version 4.1.7 onwards, and ETS5	SystemB (07B0)
2	Multifunctional heating actuator application: Activation of up to 6 valve outputs for electrothermal actuators by 1-bit or 1-byte command values. This application replaces the application "Heating actuator basic 6-gang 20D111".	Heating actuator Basic, 6-gang 20D112	1.2 for ETS3.0, Version d onwards, ETS4 Version 4.1.7 onwards, and ETS5	SystemB (07B0)

4.2 Software "Heating actuator basic 6-gang 20D11x"

4.2.1 Scope of functions

- 6 independent electronic valve outputs.
- Valve activation (deenergised opened / closed) can be configured for each output.
- Actuator evaluation as "Switching, 1-bit" or "Constant, 1-byte". With a 1-byte command value, the outputs are activated by pulse width modulation (PWM). The cycle time can be configured for each valve output.
- Overload and short-circuit signal can be set separately via a 1-bit object for each valve output (polarity can be configured).
- Pump control for activation of a circulation pump of the heating or cooling circuit via a 1-bit KNX telegram with limiting value evaluation.
- Cyclical monitoring of the command value of each output can be set, taking into account a configurable monitoring time. If no telegram is received within the preset monitoring time, the valve output concerned switches to emergency operation. The fault telegram is configurable.
- Automatic valve rinsing to prevent calcification or sticking of a valve which has not been activated for some time.
- Reactions on bus voltage return can be set for each valve output.

4.2.2 Notes on software

ETS project design and commissioning

For project design and commissioning of this device, we recommend using the ETS4 of Version 4.1.7 onwards or ETS5. Project designing and commissioning of the device using ETS3 from version "d" is also possible.

Application programs

Two ETS application programs are available for the heating actuator. The application program "Heating actuator basic 6-gang 20D111" (version 1.1) supports exclusively the data format "switching (1-bit)" for KNX command variable inputs. The application program "Heating actuator basic 6-gang 20D112" (version 1.2) also allows continuous 1-byte command variables to be evaluated. Other functions are identical in comparison to both application programs. Running the ETS4/ETS5 function "Update application program version" is not possible when using both application programs in an ETS project due to compatibility with ETS3.

Safe-state mode

If the device - for instance as a result of errors in the project design or during commissioning - does not work properly, the execution of the loaded application program can be halted by activating the safe-state mode. In safe-state mode, activation of the valve outputs via the KNX or manual operation is not possible. The actuator remains passive in safe-state mode, since the application program is not being executed (state of execution: Terminated). Only the system software is still functional so that the ETS diagnosis functions and also programming of the device continue to be possible.

Activating the safe-state mode

- Switch off the bus voltage. Wait a bit.
- Press and hold down the programming button.
- Switch on the bus voltage. Release the programming button only after the programming LED starts flashing slowly.



The safe-state mode is activated. With a new brief press of the programming button, the programming mode can be switched on and off as usual also in the safe-state mode. The programming LED stops flashing. However, safe-state mode remains active.

-  The safe-state mode can be terminated by switching off the bus voltage or by programming with the ETS.

Unloading the application program

The application program can be unloaded with the ETS. In this case the device is without function.

4.2.3 Object table

Function:	Pump control				
Object	Function	Name	Type	DPT	Flag
 ²	Switch pump	Pump - output	1-bit	1.001	C, -, T, R
Description	<p>1-bit output object for direct activation of a circulation pump of the heating or cooling system. The pump is only switched on by the actuator when at least one command value of the assigned outputs exceeds a limiting value with hysteresis defined in the ETS. The pump is switched off when the limiting value is reached or undershot again.</p> <p>The telegram polarity can be configured. After bus voltage return and an ETS programming operation, the actuator always first transmits the status "Pump OFF" without a delay. The actuator then updates the status to "Pump ON", providing that the condition for this has been fulfilled and an optionally configured "Pump delay ACTIVE" has elapsed.</p>				
Function:	Command value presetting				
Object	Function	Name	Type	DPT	Flag
 ^{20, 70, 120, 170, 220, 270}	Command value	Valve output X - Input (X = 1...6)	1-bit	1,001	C, W, -, (R) ₁
Description	<p>1-bit input object for the presetting of a switching command value, e.g. of a KNX room temperature controller. In this case, the telegram polarity is fixed: "0" = Close valve, "1" = Open valve. The configured valve direction of action is taken into account in the electrical activation of the valve.</p>				
Function:	Command value presetting				
Object	Function	Name	Type	DPT	Flag
 ^{21, 71, 121, 171, 221, 271}	Command value	Valve output X - Input (X = 1...6)	1 bytes	5,001	C, W, -, (R) ₁
Description	<p>1-byte input object for the presetting of a constant command value, e.g. of a KNX room temperature controller (0...100 % -> 0...255). This object is only available for valve outputs configured in the ETS to the command value data format "Constant (1-byte) with pulse width modulation (PWM)". The telegram value is implemented by the actuator with an equivalent pulse-width-modulated switch signal at the valve outputs. The duty factor is adapted constantly by the actuator, depending on the command value received. The cycle time can be configured in the ETS. In accordance with the configured valve direction of action, the output is either energised or deenergised, depending on the valve position to be approached. In so doing, the duty factor is inverted automatically for a deenergised opened drive.</p> <p>This object is only available with the application program "Heating actuator basic 6-gang 20D112" (version 1.2)!</p>				

1: For reading, the R-flag must be set. The last value written to the object via the bus will be read.

Function: Command value monitoring

Object	Function	Name	Type	DPT	Flag
 25, 75, 125, 175, 225, 275	Command value fault	Valve output X - Output (X = 1...6)	1-bit	1.005	C, -, T, R

Description 1-bit output object to signal a faulty command value (with active command value monitoring, no command value telegram was received within the monitoring time). The telegram polarity can be configured. Immediately after the bus voltage return or an ETS programming operation, the object "Command value fault" does not transmit the status automatically. A faulty command value must be detected again (expiry of the monitoring time without a command value telegram) for the object value to be transmitted. This is also the case if a saved emergency operation was restored after a device reset.

Function: Valve rinsing

Object	Function	Name	Type	DPT	Flag
 27, 77, 127, 177, 227, 277	Valve rinsing start Valve rinsing start / stop	Valve output X - Input (X = 1...6)	1-bit	1.003	C, W, -, (R) ¹

Description 1-bit input object for starting and stopping valve rinsing. Valve rinsing can be activated by time or an event using this object. It is also possible, for example, to cascade multiple heating actuators, so that they perform valve rinsing simultaneously (link of the individual status objects to the input objects of the valve rinsing). The telegram polarity can be configured. Stopping can be prevented via the object as an option. The time of cyclical valve rinsing is restarted as soon as an externally started valve rinsing operation is stopped by a Stop telegram or by the expiry of the rinsing time. Updates of the object from "Start" to "Start" or "Stop" to "Stop" do not produce a reaction. The length of an elapsing valve rinsing operation or the cycle time of the cyclical valve rinsing are not restarted by this.

Function: Valve rinsing

Object	Function	Name	Type	DPT	Flag
 28, 78, 128, 178, 228, 278	Valve rinsing status	Valve output X - Output (X = 1...6)	1-bit	1.002	C, -, T, R

Description 1-bit output object for status feedback of a valve rinsing operation. The telegram polarity is fixed: "0" = Valve rinsing inactive, "1" = Valve rinsing active. The object transmits the current status after bus and mains voltage return and after an ETS programming operation without a delay.

1: For reading, the R-flag must be set. The last value written to the object via the bus will be read.

Function:	Overload / short-circuit identification				
Object	Function	Name	Type	DPT	Flag
<input type="checkbox"/> ← 29, 79, 129, 179, 229, 279	Signal short-circuit /overload	Valve output X - Output (X = 1...6)	1-bit	1.005	C, -, T, R
Description	1-bit output object to signal an identified overload or a short-circuit at the affected valve output. The telegram polarity can be configured. The object always transmits the current status after bus voltage return and an ETS programming operation after a delay, providing that a delay after bus voltage return has been configured on the "General" parameter page.				

4.2.4 Functional description

4.2.4.1 Description of channel-independent functions

4.2.4.1.1 Priorities

The heating actuator distinguishes between various functions and events, which either affect all of some of the assigned valve drives globally, or only specifically affect individual outputs. Because these functions and events cannot be executed simultaneously, there must be priority control. Each global or output-orientated function and each incoming event possesses a priority. The function or the event with the higher priority overrides the lower-priority functions and events.

The following priorities are defined...

- Overload / short-circuit (highest priority)
- Behaviour after ETS programming
- Behaviour in case of bus voltage return / bus voltage failure
- Valve rinsing
- Emergency operation (through cyclical monitoring of the command value)
- Normal operation (activation using command value telegrams)

i The behaviour after an ETS programming operation is only executed if there have been changes in the configuration of the device. If just an application download is executed with a project design already located in the actuator, then the actuator will executed the behaviour after bus voltage return.

4.2.4.1.2 Pump control

The heating actuator allows switching activation of the circulation pump of the heating or cooling circuit via a 1-bit KNX telegram. When using the pump controller, the pump is only switched on by the actuator via the "Switch pump" object, when at least one command value of the assigned outputs is not equal to "0 - OFF". This saves electrical energy, as the pump only runs when valve outputs are opened.

- i** If emergency operation is active, affected valve outputs are always activated by a constant command value with pulse width modulation (PWM), provided that command values not equal to 0 % or 100 % are to be set. PWM is executed until emergency operation is terminated. In this case, the constant command value set by the PWM is also included in the pump control. The pump is switched on for command values 1...100 %.
- i** After bus voltage return and an ETS programming operation, the actuator always first transmits the status "Pump OFF" without a delay. The actuator then updates the status to "Pump ON", providing that the condition for this has been fulfilled and an optionally configured "Pump delay ACTIVE" has elapsed.
- i** A valve output affected by a short-circuit / overload (valve completely closed on deenergised closed or completely opened on deenergised opened) does not influence the pump control.

The actuator only outputs the ON telegram to the pump after determination when the defined delay time has elapsed. The pump is not switched on when the actuator determines within the preset time that the pump must remain switched off due to inactive command values.

The actuator only outputs the OFF telegram to the pump after determination of inactive command values only after a preset delay time of 10 minutes.

The ACTIVE delay time of the pump controller can be used as an example to match the running time of the pump to the reaction time of the actuated actuators. Thus, a pump should only switch on when the actuators actually open after electrical activation by the actuator (match pump ACTIVE delay with the dead time of the actuators).

Enabling and configuring the pump control function

The pump control must be enabled on the "Pump" parameter page, so that it can be used during actuator operation.

- Set the "Activate 'Pump control' function ?" parameter to "yes". Configure the parameter "Polarity of 'Pump control' object" to the required telegram polarity.

Pump control is activated. The pump is switched on according to the set telegram polarity, if at least one command value of the assigned valve outputs becomes active ("1 - ON" or emergency operation "1...100 %"). The pump is switched off as soon as all the assigned valve outputs have a command value "0 - OFF".
The valve outputs must be assigned to the pump control individually on the parameter pages "Ax - Assignments", so that they are included in the command value evaluation.
- Set the "Activate 'Pump control' function ?" parameter to "no".

Pump control is not available.

Configure delay for pump control

If necessary, the pump switch-on can be delayed. The switch-off is always delayed by 10 minutes.

- Set the parameter "Delay pump ACTIVE" to the desired time.

The actuator only outputs the ON telegram to the pump after determination when the defined delay time has elapsed. The pump is not switched on when the actuator determines within the preset time that the pump must remain switched off due to inactive command values.

4.2.4.2 Channel-oriented functional description

4.2.4.2.1 Valve direction of action

The heating actuator possesses 6 electronic outputs, each of which can silently activate up to 4 (AC 230 V) or 2 (AC 24 V) actuators. Both deenergised closed and deenergised opened actuators can be connected. The parameter "Valve in voltage-free state (valve direction of action)" on the parameter pages "Ax - General" specifies which device type is connected to a valve output.

i Only actuators with the same characteristics may be connected to each valve output (deenergised closed/opened). The drive type must match the configuration.

The configured valve direction of action is taken into account in each valve activation. With 1-byte command values and deenergised closed valves, the switch-on time is derived directly from the configured PWM and the cycle time.

Example: PWM = 30 %, cycle time = 10 minutes -> Switch-on time = 3 minutes, switch-off time = 7 minutes.

In the case of 1-byte command values and deenergised opened valves, the switch-on time is inverted. Example: PWM = 30 %, cycle time = 10 minutes -> Switch-on time = 7 minutes, switch-off time = 3 minutes.

On deenergised closed valve drives, command values are not inverted, in accordance with the 1-bit data format. Example: Command value ON -> Output switched on, Command value OFF -> Output switched off.

By contrast, switching command values are inverted for deenergised opened valve drives. Example: Command value ON -> Output switched off, Command value OFF -> Output switched on.

i In the state as supplied, the valve direction of action for all the valve outputs is set to "Deenergised closed".

4.2.4.2.2 Reset behaviour

The states of the valve outputs after a bus voltage failure and after an ETS programming operation are permanently preset. The behaviour after bus voltage return is configured in the ETS.

Behaviour in case of bus voltage failure

In this case, even if valve voltage is available, the valve outputs will always switch off when there is a bus voltage failure, as the device electronics are no longer being supplied with energy and, as a result, the actuator is unable to function. In this state of operation, deenergised closed valve drives close completely and deenergised opened valve drives open. The configured valve direction of action can no longer be evaluated if the bus voltage fails.

- i If there is a bus voltage failure, the actuator saves the active command value internally in the device, so that the command value can be restored when the device power supply returns (configurable). Saving only takes place after a previous device reset (ETS programming operation, bus voltage return) when the reset is longer than 30 seconds previously. Otherwise the actuator does not save the current command value! In that case, an old value remains valid, as was previously saved by the actuator on the bus voltage failure.

Setting the behaviour after bus voltage return

The parameter "Behaviour in case of bus voltage return" is available separately for each valve output on the parameter page "Ax - General".

- Set the parameter to "Command value 0 % (Close valve)".
The actuator then closes the valve output completely.
- Set the parameter to "Activate command value as for emergency operation".
For the valve output, the actuator polls the emergency operation command value, as configured in the ETS. Ensure that, in this setting, emergency operation is not executed (as would be the case if there was a faulty command value found in the course of command value monitoring)! The actuator only polls the command value preset for emergency operation.
- Set the parameter to "Command value as before bus voltage failure".
After bus voltage return, that command value is set at the valve output which was active at the moment of the last bus voltage failure. If there is a bus voltage failure, the actuator saves the active command value internally in the device, so that the command value can be restored when the device power supply returns. Saving only takes place after a previous device reset (ETS programming operation, bus voltage return) when the reset is longer than 30 seconds previously. Otherwise the actuator does not save the current command value! In that case, an old value remains valid, as was previously saved by the actuator on the bus voltage failure.

Behaviour after ETS programming

After an ETS programming operation, the actuator always closes the valve drives.

- i The behaviour after an ETS programming operation is only executed if there have been changes in the configuration of the device. If just an application download is executed with a project design already located in the actuator, then the actuator will execute the configured "Behaviour after bus voltage return".

4.2.4.2.3 Data formats for command values

The heating actuator receives 1-bit or 1-byte command value telegrams, transmitted, for example, by KNX room temperature controllers. Usually, the room temperature controller determines the room temperature and generates the command value telegrams using a control algorithm. The actuator controls its valve outputs either in switching form or with a PWM signal, according to the data format of the command values and the configuration in the ETS. The cycle time for constant PWM output signals can be configured separately for each valve output of the heating actuator. This allows individual adaptation to different actuator types.

- i** It should be noted that the heating actuator does not carry out temperature control itself. The actuator converts received command value telegrams or command value presets from device functions into constant or switching output signals.

The "Data format of the command value input" parameter, which is only available with the application program "Heating actuator Basic 6-gang 20D112" (version 1.2) separately for each valve output on the parameter pages "Ax - Command values/Status/Operating mode", specifies the input format of the command value objects.

- i** The data format of the KNX command variable inputs is permanently set to "1-bit" for the application program "Heating actuator basic 6-gang 20D111" (version 1.1).

Data format of the command value input "Switching (1-bit)"

In the case of a 1-bit command value, the telegram received via the command value object is forwarded directly to the appropriate output of the actuator, taking the configured valve direction of action into account. This means that, if an "ON" telegram is received, the valve is completely opened. The output is then energised for energised closed valves and the output is deenergised for energised opened valve drives. The valve is closed completely when an "OFF" telegram is received. The valve output is then not energised for deenergised closed valves and energised for deenergised opened valve drives.

In the functions and events listed below, valve outputs configured to the command value data formats "Switching (1-bit)" are always activated by a constant command value with pulse width modulation (PWM), provided that command values not equal to 0 % or 100 % are to be set...

- Active emergency operation,
- On bus voltage failure,
- After bus voltage return (in the setting "Activate command as for emergency operation").

PWM keeps being executed until the named functions have been exited or, after the named events, no more lower-level functions are active and a new command value telegram is received via the bus, overriding the constant command value on the valve output.

- i** In the named cases, the constant command value is also included in the pump control (optional function).
- i** Valve outputs, which receive preset command values via the data format "Switching (1-bit)", influence the pump control. Here, an "OFF" command value is interpreted as "0 %" and an "ON" command value as "100 %".

Data format of the command value input "Constant (1-byte) with pulse width modulation (PWM)" (only with the application program "Heating actuator basic 6-gang 20D112")

Command values corresponding to the data format "Constant (1-byte)" are implemented by the actuator with an equivalent pulse-width-modulated switch signal at the valve outputs. Taking the cycle time settable in the actuator for each output into account, the average output signal resulting from this modulation is a measure of the centred valve position of the control valve and thus a reference for the set room temperature. A shift of the mean value, and thus a change in the heating capacity, can be obtained by changing the duty factor of the switch-on and switch-

off pulses of the output signal (Figure 4). The duty factor is adapted constantly by the actuator, depending on the command value received (normal operation) or by active device functions (e.g. emergency operation).

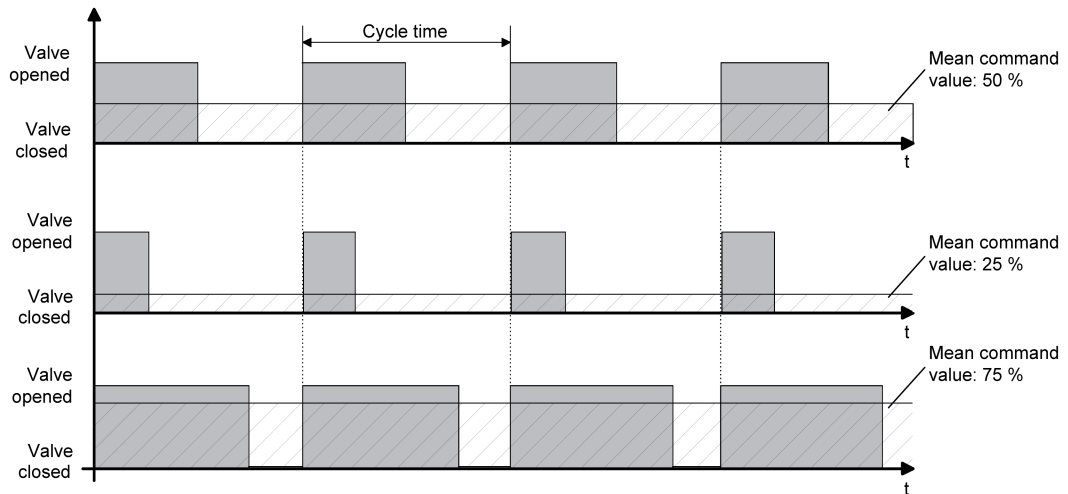

Figure 4: Resulting mean value through variable duty factor with pulse width modulation

In accordance with the configured valve direction of action, the appropriate outputs are either energised or deenergised, depending on the valve position to be approached. In so doing, the duty factor is inverted automatically for a deenergised opened drive. Thus, depending on the valve type used, there is no unintended mean value shift.

Example: Command value: 60 % ->

- Duty factor, deenergised closed: 60 % ON, 40 % OFF,
- Duty factor, deenergised opened: 40 % ON, 60 % OFF.

Example: Command value: 100 % ->

- Duty factor, deenergised closed: Permanently ON,
- Duty factor, deenergised opened: Permanently OFF.

Often, control circuits are subject to non-constant changes in the setpoint presetting (e.g. frost protection, night operation, etc.) or short-time interference (e.g. measured value deviations due to brief opening of windows or doors near the sensor). For the setting of the scanning ratio of the required command value to take place as quickly and correctly in these cases, even with a longer set cycle time, without any negative impact on the reaction time of the control section, the actuator uses a special method for continuous command value adjustment.

The following cases are taken into account...

- Case 1
Command value change, e.g. from 80 % to 30 %, during the opening phase of the valve (Figure 5).
Before the reception of the new command value (30 %), the old setpoint (80 %) was active. The new command value is received during the opening phase of the valve. At this point, the actuator detects that it is still possible to shorten the opening phase, so that it corresponds to the new command value (30 %). The cycle time is not affected by this operation.
The new duty factor is set immediately after the reception of the new command value.

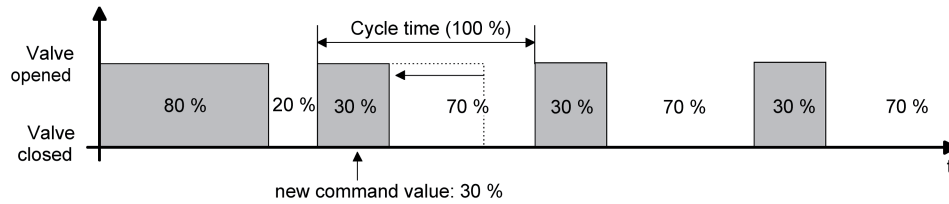

Figure 5: Example of a command value change 80 % -> 30 % during the opening phase of the valve

- **Case 2**

Command value change, e.g. from 80 % to 30 %, during the closing phase of the valve (Figure 6).

Before the reception of the new command value (30 %), the old setpoint (80 %) was active. The new command value is received during the closing phase of the valve. At this point, the actuator detects that it is still possible to extend the closing phase, so that it corresponds to the new command value (30 %). The cycle time remains unchanged, but the starting time of the period is shifted automatically.

The new duty factor is set immediately after the reception of the new command value.

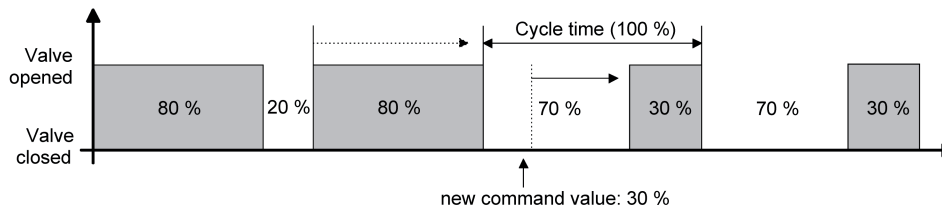

Figure 6: Example of a command value change 80 % -> 30 % during the closing phase of the valve

- **Case 3**

Command value change, e.g. from 80 % to 30 % during the opening phase of the valve (opening phase too long) (Figure 7).

Before the reception of the new command value (30 %), the old setpoint (80 %) was active. The new command value is received during the opening phase of the valve. At this point, the actuator detects that it is necessary to cancel the opening phase immediately and close the valve, so that the duty factor corresponds to the new command value (30 %). The cycle time remains unchanged, but the starting time of the period is shifted automatically.

The new duty factor is set immediately after the reception of the new command value.

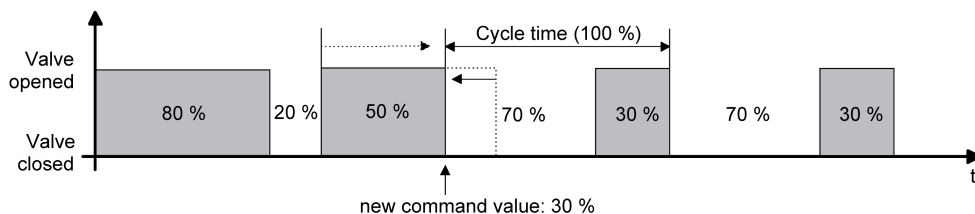

Figure 7: Example of a command value change 80 % -> 30 % during the opening phase of the valve (opening phase too long)

- **Case 4**
 Command value change, e.g. from 30 % to 80 %, during the opening phase of the valve (Figure 8).
 Before the reception of the new command value (80 %), the old setpoint (30 %) was active. The new command value is received during the opening phase of the valve. At this point, the actuator detects that it is still possible to extend the open phase, so that it corresponds to the new command value (80 %). The cycle time is not affected by this operation. The new duty factor is set immediately after the reception of the new command value.

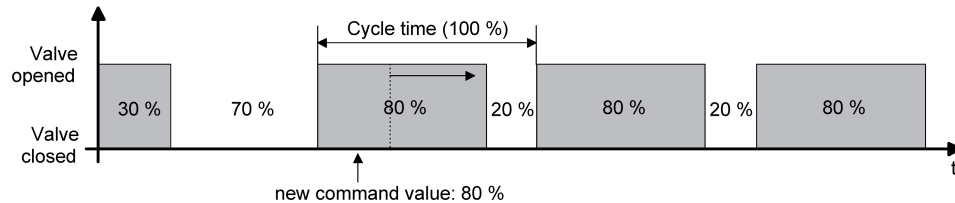

Figure 8: Example of a command value change 30 % -> 80 % during the opening phase of the valve

- **Case 5**
 Command value change, e.g. from 30 % to 80 %, during the closing phase of the valve (Figure 9).
 Before the reception of the new command value (80 %), the old setpoint (30 %) was active. The new command value is received during the closing phase of the valve. At this point, the actuator detects that it is still possible to reduce the closing phase, so that it corresponds to the new command value (80 %). The cycle time remains unchanged, but the starting time of the period is shifted automatically. The new duty factor is set immediately after the reception of the new command value.

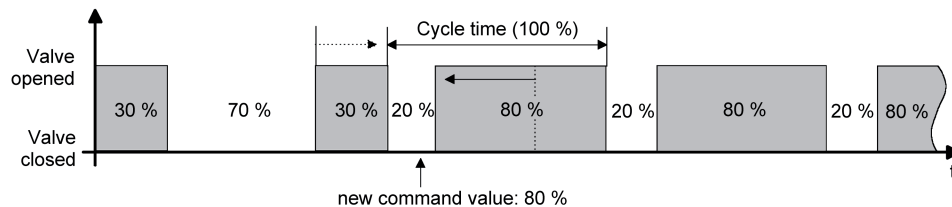

Figure 9: Example of a command value change 30 % -> 80 % during the closing phase of the valve

- **Case 6**
 Command value change, e.g. from 30 % to 80 %, during the closing phase of the valve (closing phase too long) (Figure 10).
 Before the reception of the new command value (80 %), the old setpoint (30 %) was active. The new command value is received during the closing phase of the valve. At this point, the actuator detects that it is necessary to cancel the closing phase immediately and open the valve, so that the duty factor corresponds to the new command value (80 %). The cycle time remains unchanged, but the starting time of the period is shifted automatically. The new duty factor is set immediately after the reception of the new command value.

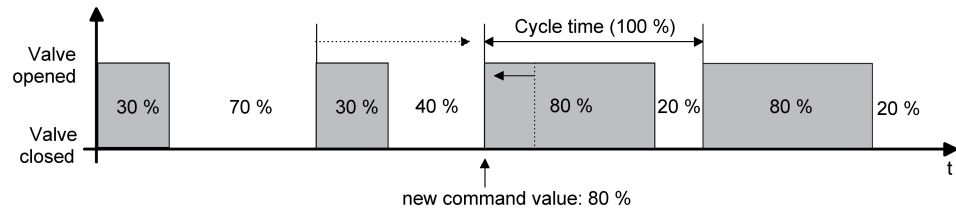

Figure 10: Example of a command value change 30 % -> 80 % during the opening phase of the valve (opening phase too long)

4.2.4.2.4 Cycle time

The "Cycle time" parameter specifies the period length of the pulse-width-modulated output signal of a valve output. It allows adaptation to the adjusting cycle times (the adjusting time it takes the drive to bring the valve from its completely closed to its completely opened position) of the actuators used. In addition to the adjusting cycle time, take account of the dead time (the time in which the actuators do not show any response when being switched or off). If different actuators with different adjusting cycle times are used at an output, take account of the longest of the times.

- i** The "Cycle time" parameter is also available for valve drives, whose command value data format is configured to "Switching (1-bit)". For such valve outputs, pulse width modulation can also be executed during an active emergency operation or after bus voltage return, for which, as a result, the presetting of a cycle time is required.
- The data format of the KNX command variable inputs is permanently set to "1-bit" for the application program "Heating actuator basic 6-gang 20D111" (version 1.1). Consequently, a pulse width modulation is then only executed in an emergency mode or after bus voltage return, if configured.

Generally, two different options of how to set the cycle time can be identified:

Case 1

Cycle time > 2 x Adjusting cycle time of the drives used (ETA)

In this case, the switch-on and switch-off times of the actuator are long enough for the actuators to have sufficient time to fully open and fully close within a given period (Figure 11).

- **Advantage:**
The desired mean value for the command value and thus for the required room temperature will be set relatively precisely, even for several actuators triggered at the same time.
 - **Disadvantage:**
It should be noted, that, due to the full valve lift, the life expectancy of the actuators can diminish. For very long cycle times (> 15 minutes) with less sluggishness in the system, the heat emission into the room, for example, in the vicinity of the radiators, can possibly be non-uniform and be found disturbing.
- i** This cycle time setting is recommended for slower, more sluggish heating systems (such as underfloor heating).
- i** Even for a bigger number of triggered actuators, maybe of different types, this setting can be recommended to be able to obtain a better mean value of the adjusting travels of the valves.

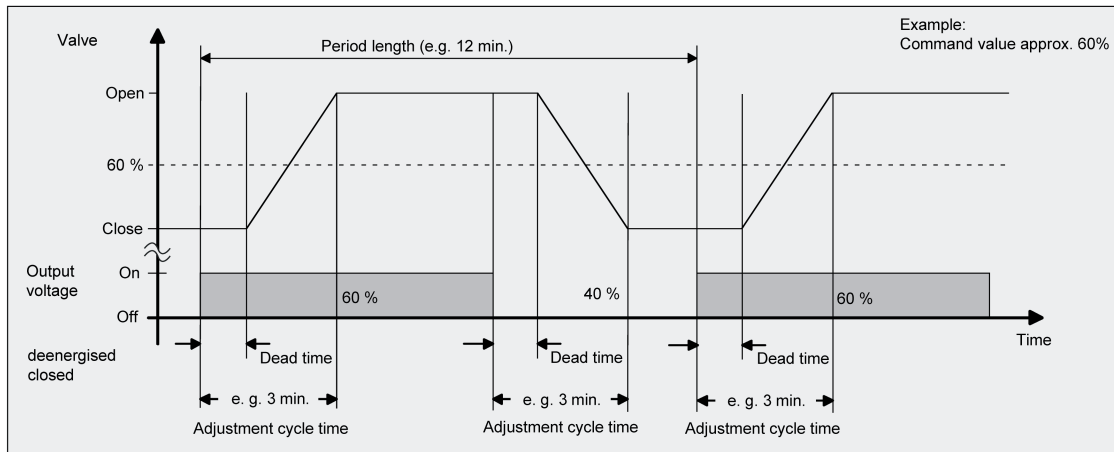

Figure 11: Ideal course of the valve stroke for a cycle time > 2 x Adjustment cycle time

Case 2

Cycle time < Adjusting cycle time of the drives used (ETA)

In this case, the switch-on and switch-off times of the actuator are too short for the actuators to have enough time to fully open and fully close within a given period (Figure 12).

- Advantage: This setting ensures continuous water flow through the radiators, thus facilitating uniform heat emission into the room. If only one actuator is triggered the regulator can continuously adapt the variable to compensate the mean value shift caused by the short cycle time, thus setting the desired room temperature.
- Disadvantage: If more than one actuator is activated at the same time, the desired mean value will become the variable, which will result in a very poor adjustment of the required room temperature, or in adjustment of the latter with major deviations, respectively.

i This setting is recommended for quicker heating systems (such as radiators).

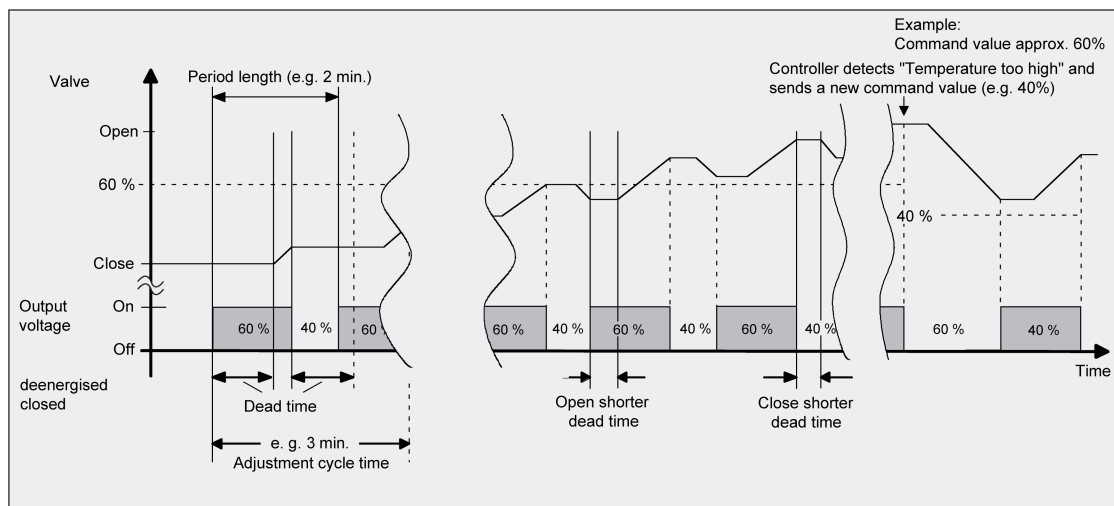

Figure 12: Ideal course of the valve stroke for a cycle time < Adjustment cycle time

The continuous flow of water through the valve, and thus the continuous heating of the drives causes variations and changes to the dead times of the drives during the opening and closing

phase. The short cycle time and the dead times means that the required command value (mean value) is only set with a possibly large deviation. For the room temperature to be regulated constantly after a set time, the controller must continually adjust the command value to compensate for the mean value shift caused by the short cycle time. Usually, the control algorithm implemented in the controller (PI control) ensures that control deviations are compensated.

4.2.4.2.5 Cyclical command value monitoring / emergency operation

If necessary, cyclical monitoring of the command values can be performed. If, during active cyclical monitoring, there are no command value telegrams during a preset time, then emergency operation is activated for the affected valve output, for which a configurable constant PWM command value can be preset in the ETS.

The command value of emergency operation is always constant and is configured individually in the ETS (0...100 % in 10 % steps). The command value is executed electrically at the output using a pulse width modulation (PWM).

- i** If emergency operation is active, valve outputs are always activated by a constant command value with pulse width modulation.
- i** The configured valve direction of action (deenergised closed / deenergised opened) is taken into account in the electrical activation of the outputs by emergency operation. With deenergised closed valves, the switch-on time is derived directly from the configured PWM and the cycle time. In the case of deenergised opened valves, the switch-on time is inverted.

If command value monitoring is enabled, then the actuator will check the arrival of telegrams on the command value object during a settable time period. The time period is defined separately for each valve output by the "Monitoring time" parameter. The time set there should be at least double the time for the cyclical transmission of the command value of the controller, in order to ensure that at least one telegram is received within the monitoring time. Cyclical command value monitoring takes place continuously. The actuator retriggers the monitoring time automatically on each command value telegram received and after a device reset. If there are no command value telegrams during the monitoring time, then the actuator will activate emergency operation.

According to the priority control, active command value monitoring can be overridden by other device functions with a higher priority (e.g. valve rinsing). At the end of a higher priority function, the actuator executes emergency operation for the valve outputs concerned once again, if it is still activated by missing command value telegrams.

Optionally, the emergency operation command value can also be activated in case of bus voltage return (configurable). This is only the recall of the configured command value and not the activation of emergency operation, as takes place during command value monitoring.

At the end of emergency operation (new input command value received), the behaviour of a valve output is permanently defined. If no function with a higher priority is active, the actuator always tracks the state for the affected valve outputs most recently preset by normal bus operation (activation by command value telegrams).

- i** After a device reset (bus voltage return, ETS programming operation), the command value objects first contain the value "0".
- i** The state of emergency operation (active or inactive) is saved internally in the device after a bus voltage failure and is restored automatically after a bus voltage return. After a bus voltage return, the actuator activates emergency operation, if the tracked state allows this.

The actuator makes the 1-bit status telegram "Command value fault" available. As soon as a command value telegram is missing on a monitored valve output, and thus emergency operation is activated, then the actuator transmits a fault signal via this status object. The telegram polarity can be configured. Only after at least one command value telegram has been received for the monitored valve output does the actuator retract the fault signal for cyclical monitoring. Optionally, the fault telegram can also be transmitted cyclically during active emergency operation.

- i** Immediately after the bus voltage return or an ETS programming operation, the object "Command value fault" does not transmit the status automatically. A faulty command value must be detected again (expiry of the monitoring time without a command value telegram) for the object value to be transmitted. This is also the case if a saved emergency operation was restored after a device reset.

Enable cyclical command value monitoring

Cyclical command value monitoring can only be used if it has been enabled in the ETS.

- Set the parameter "Activate command value monitoring ?" on parameter page "Ax - Command value/Status/Operating mode" to "Yes". Configure the "Monitoring time" of the command value monitoring.

Cyclical command value monitoring is activated. If there are no command value telegrams during the monitoring time preset by the parameter of the same name, then emergency operation is activated for the affected valve output, for which the actuator sets to a configurable constant PWM command value. This command value is defined by the "Command value in the case of emergency operation" parameter.

- Set the parameter "Activate command value monitoring ?" to "no".
Cyclical command value monitoring is deactivated.

Configuring the fault signal for cyclical command value monitoring

If a command value fault is identified, then the actuator can optionally transmit a fault telegram via the object "Command value fault".

- Set the parameter "Polarity of 'Command value fault' object" on parameter page "Ax - Command value/Status/Operating mode" to the required telegram polarity.

As soon as a command value telegram is missing on a monitored valve output, and thus emergency operation is activated, then the actuator transmits a fault signal via the status object "Command value fault" according to the configured telegram polarity. Only after at least one command value telegram has been received for the monitored valve output does the actuator retract the fault signal for cyclical monitoring.

- Set the parameter "Cyclical transmission in the case of faulty command value ?" to "yes".
If a command value fault is identified, then the actuator transmits the fault telegram cyclically. The cycle time is defined for all cyclical status and feedback functions on the "General" parameter page.
- Set the parameter "Cyclical transmission in the case of faulty command value ?" to "no".
If a command value fault is identified, then the actuator transmits the fault telegram only once.

4.2.4.2.6 Short-circuit and overload detection

The actuator is able to detect an electrical overload or a short-circuit at the valve outputs and to protect them against destruction by switching off. Outputs which have experienced a short-circuit or a constant load are deactivated after an identification period. Optionally, in this case short-circuit/overload signals can be transmitted via separate 1-bit communication objects. Short-circuit / overload detection is always active when a valve output is switched on (output energised) and always occurs in two output groups. Here, outputs 1 to 3 and outputs 4 to 6 each form a group. If there is an error, the actuator will only detect an overload / a short-circuit in a group at first. Therefore, the actuator then executes a special testing cycle, which guarantees safe detection of the valve outputs which are actually electrically overloaded. Only after overloaded or short-circuited valve outputs have been accurately determined is it possible to output overload/short-circuit signals to the bus. After error detection in a group, all the outputs in this group are immediately deactivated for 6 minutes (switch-off idle phase / outputs not energised). During this time, the error detection circuit resets thermally.

Testing cycle

During the testing cycle, the actuator applies stepped, time-offset switch-on and deactivation of each valve output of the affected group to determine the outputs which are overloaded or shorted and which thus led to the error switch-off. In the case of a weak overload at, for example, one valve output, it may occur during the testing cycle that, during the individual testing of the output during the switch-on phase, no overload is detected, as the overload is too slight. This means that it may be necessary to start multiple testing cycles, until the overloaded output can be identified clearly. Each output group is equipped with a counter, which saves the number of testing cycles started for a group up to that point. Each time it is not possible to determine clearly if a valve output is overloaded or short-circuited during a testing cycle, then the counter will counter upwards by one increment. If another error is detected in an output group unsuccessfully tested for overload / short-circuit (current counter status > "0"), then the outputs will be energised with a longer switch-on time in the new testing cycle. In the first testing cycle, the switch-on time is 1 second, in the 2nd cycle 10 seconds, in the 3rd cycle 1 minute and, in the 4th cycle, 4 minutes.

The current counter status is only saved in the device and cannot be read out.

If there is a collective overload, various weak overloads, possibly at multiple outputs, have collected into a stronger overall overload. If there is a collective overload, it may occur that, even after four testing cycles, no output can be clearly identified as overloaded. In this case, after the fourth cycle, the actuator will deactivate individual valve outputs of an output group, until no overload exists.

Here is the testing cycle for the identification of overloaded or short-circuited valve outputs in detail...

- 1.
An overload or short-circuit was detected in a group. The actuator deactivates all the valve outputs of the affected group. The switch-off idle phase (6 minutes) is started.

- 2.
The first valve output of the affected group (output 1 or output 4) switches on for approx. 1 second, if this output was not previously deactivated by a previous testing cycle. If the output was previously deactivated, then the actuator switches the next output on (output 2 or output 4, etc.).

- 2. a
If, during the switch-on time, no overload or no short-circuit is detected because the overload / the short-circuit is pending at another output or is too slight (weak overload), then the output will be switched off again. Continue with Step 3.

- 2. b
If, at the tested valve output, an overload or a short-circuit is detected, then a forced switch-off takes place immediately at this output. The output is deactivated. Then a switch-off idle phase of 6 minutes is started, during which the error detection circuit resets thermally. During this time, the affected output group remains completely switched off.

 - 3.
The output test started under Step 2 is continued with the next output, which has not been deactivated, in the appropriate group in the same fashion, with a time gap of approx. 4 seconds from output test to output test, until the last valve output of the group or both groups has been processed.

 - 4.
The testing cycle is then finally exited when all the valve outputs or both groups have been processed.

 - 4. a
The valve outputs detected as overloaded or having shorted in the testing cycle of the group(s) now remain deactivated and cannot be switched on again until the reset. The testing cycle counter is deleted. All the unaffected valve outputs are again activated normally.

 - 4. b
If, during the testing cycle, no output was detected as being overloaded or having shorted (probable weaker overload), then the testing cycle counter for this/these group(s) will count upwards, so that, in the next cycle, all the affected valve outputs are tested with an extended switch-on time, in order to detect weaker overloads.
Exception: If the previously executed testing operation was the 4th sequence in succession without any error detection, then the actuator will assume that this is a collective overload at multiple outputs. In this case, the actuator will automatically deactivate one output of the affected group (output 3 or output 6), according to the priority. In so doing, the testing cycle counter will be deleted as for regular identification of an error, and testing again occurs with a 1 s switch-on time in the next cycle. If 4 cycles again occur after this, without outputs being detected as overloaded or having shorted during the individual test, then the actuator will again assume a collective overload and will automatically permanently deactivate the next outputs of the group(s) (firstly output 2 and/or output 5, then, after four more cycles, output 1 and/or output 4).

 - 5.
All the valve outputs not deactivated in the testing cycles then continue to work normally.
- i** If possible, connect actuators for environments with increased fail-safety requirements to the outputs 1 and 4. During overload detection, these are switched off last, as described.
 - i** Signal telegrams, if configured for a valve output in the ETS, are only generated for those valve outputs which were forcibly deactivated by priority in the testing cycle, after the detection of an error or a collective overload.
 - i** The resetting of an overload or a short-circuit during a testing cycle is ignored.
 - i** To give less weight to detected overloads caused by rare, extreme interference, such as strong electromagnetic coupling into the low-voltage network (lightning strike close by), the cycle counter is reduced by 1 after a period of 28 days without the detection of a further overload or a new short-circuit. This ensures that, after long periods of time, valve outputs are not simply switched off after the 4th cycle without identification of a clear overload or a short circuit.

- i** A valve output switched off via the bus (output not energised) can also be energised during the overload or short-circuit detection phase for the period of time defined in the testing cycle.
- i** A valve output affected by a short-circuit / overload (valve completely closed on deenergised closed or completely opened on deenergised opened) does not influence the pump control.

Examples of overload / short-circuit detection...

Example 1

Error case = Short-circuit at valve output 4.

A short-circuit generates a short-circuit/overload signal in output group A4...A6. This produces the following sequence...

Test time	Outputs						KNX message						Comment
	1	2	3	4	5	6	1	2	3	4	5	6	
6min	N	N	N	0	0	0	-	-	-	-	-	-	Overload only affects one group!
<1s	N	N	N	1	0	0	-	-	-	T	-	-	Check output 4 4 s later → Short-circuit
6min	N	N	N	0	0	0	-	-	-	-	-	-	Switch-off idle phase. Short-circuit message
1s	N	N	N	0	1	0	-	-	-	-	-	-	Check output 5 → No error
1s	N	N	N	0	0	1	-	-	-	-	-	-	Check output 6 4 s later → No error
---	N	N	N	0	N	N	-	-	-	-	-	-	Output 4 remain deactivated 4 s later! All the other outp. contin. to work "normally"!

Figure 13: Short-circuit at valve output 4

"0" Output not energised

"1" Output energised

"N" Normal operation of the valve output

"T" Short-circuit / overload identified (signal telegram is cancelled if configured)

On next error detection in group 4-6: Test switch-on time: 10 s

Example 2

Error case = Weak overload at valve output 2.

The overload is so weak that a switch-on time of 1 second does not lead to error detection. In the case of a weak overload, it should be expected that the overload/short-circuit signal only affects the directly affected output group (here: Outputs 1 to 3). This produces the following sequence...

Test time	Outputs						KNX message						Comment
	1	2	3	4	5	6	1	2	3	4	5	6	
6min	0	0	0	N	N	N	-	-	-	-	-	-	Overload only affects one group!
1s	1	0	0	N	N	N	-	-	-	-	-	-	Check output 1 → No error
1s	0	1	0	N	N	N	-	-	-	-	-	-	Check output 2 4 s later → No error
1s	0	0	1	N	N	N	-	-	-	-	-	-	Check output 3 4 s later → No error
---	N	N	N	N	N	N	-	-	-	-	-	-	4 s later: All outputs working normally.

Figure 14: Weak overload at valve output 2 / first testing cycle

On next error detection in group 1...3: Test switch-on time: 10 s
 It should be expected that, in normal operation, an overload will again be detected in the previously affected output group...

Test time	Outputs						KNX message						Comment
	1	2	3	4	5	6	1	2	3	4	5	6	
6min	0	0	0	N	N	N	-	-	-	-	-	-	Overload only affects one group!
10s	1	0	0	N	N	N	-	-	-	-	-	-	Check output 5 → No error
<10s	0	1	0	N	N	N	-	T	-	-	-	-	Check output 2 4 s later → Overload
6min	0	0	0	N	N	N	-	-	-	-	-	-	Switch-off idle phase. Overload message
10s	0	0	1	N	N	N	-	-	-	-	-	-	Check output 3 4 s later → No error
---	N	0	N	N	N	N	-	-	-	-	-	-	Output 2 remain deactivated 4 s later! All the other outputs continue to work "normally"!

Figure 15: Weak overload at valve output 2 / second testing cycle

On next error detection in group 1...3: Test switch-on time: 1 s

Example 3

Error = Total overload in output group "Output 1 to 3".

The overload of individual valve outputs is so weak that, during the testing cycles, no output can be clearly identified as overloaded or having shorted during a test switch-on time of 4 minutes. This produces the following sequence...

Test time	Outputs						KNX message						Comment
	1	2	3	4	5	6	1	2	3	4	5	6	
6min	0	0	0	N	N	N	-	-	-	-	-	-	Overload only affects one group!
1s	1	0	0	N	N	N	-	-	-	-	-	-	Check output 1 → No error
1s	0	1	0	N	N	N	-	-	-	-	-	-	Check output 2 4 s later → No error
1s	0	0	1	N	N	N	-	-	-	-	-	-	Check output 3 4 s later → No error
---	N	N	N	N	N	N	-	-	-	-	-	-	4 s later: All outputs working normally.

Figure 16: Total overload in output group 1...3 / first testing cycle

On next error detection in group 1...3: Test switch-on time: 10 s
 It should be expected that, in normal operation, an overload will again be detected in the previously affected output group...

Test time	Outputs						KNX message						Comment
	1	2	3	4	5	6	1	2	3	4	5	6	
6min	0	0	0	N	N	N	-	-	-	-	-	-	Overload only affects one group!
10s	1	0	0	N	N	N	-	-	-	-	-	-	Check output 1 → No error
10s	0	1	0	N	N	N	-	-	-	-	-	-	Check output 2 4 s later → No error
10s	0	0	1	N	N	N	-	-	-	-	-	-	Check output 3 4 s later → No error
---	N	N	N	N	N	N	-	-	-	-	-	-	4 s later: All outputs working normally.

Figure 17: Total overload in output group 1...3 / second testing cycle

On next error detection in group 1...3: Test switch-on time: 1 min.
 It should be expected that, in normal operation, an overload will again be detected in the previously affected output group...

Test time	Outputs						KNX message						Comment
	1	2	3	4	5	6	1	2	3	4	5	6	
6min	0	0	0	N	N	N	-	-	-	-	-	-	Overload only affects one group!
1min	1	0	0	N	N	N	-	-	-	-	-	-	Check output 1 → No error
1min	0	1	0	N	N	N	-	-	-	-	-	-	Check output 2 4 s later → No error
1min	0	0	1	N	N	N	-	-	-	-	-	-	Check output 3 4 s later → No error
---	N	N	N	N	N	N	-	-	-	-	-	-	4 s later: All outputs working normally.

Figure 18: Total overload in output group 1...3 / third testing cycle

On next error detection in group 1...3: Test switch-on time: 4 min.
It should be expected that, in normal operation, an overload will again be detected in the previously affected output group...

Test time	Outputs						KNX message						Comment
	1	2	3	4	5	6	1	2	3	4	5	6	
6min	0	0	0	N	N	N	-	-	-	-	-	-	Overload only affects one group!
4min	1	0	0	N	N	N	-	-	-	-	-	-	Check output 1 → No error
4min	0	1	0	N	N	N	-	-	-	-	-	-	Check output 2 4 s later → No error
4min	0	0	1	N	N	N	-	-	-	-	-	-	Check output 3 4 s later → No error
---	N	N	0	N	N	N	-	-	T	-	-	-	4 s later: Output 3 is deactivated autom. according to the priority. All the other outputs continue to work "normally"!

Figure 19: Total overload in output group 1...3 / fourth testing cycle

On next error detection in group 1-3: Test switch-on time: 1 s

Short-circuit / overload signal telegrams

Signal telegrams, are only transmitted for the outputs which were deactivated by priority in the testing cycle, after the detection of an error or a collective overload. The precondition is that the signal telegram on the parameter page "Ax - Command value/Status/Operating mode" is enabled by the "Short-circuit / overload signal ?" parameter in the "Yes" setting. The telegram polarity of the signal telegram can be configured.

An active short-circuit / overload signal remains intact after a device reset by bus voltage return. In this case as well, the short-circuit / overload signal must first be reset (see "Resetting a short-circuit / overload" below). If, before the bus voltage failure, no short-circuit and no overload was identified, then the actuator will first transmit a signal telegram "No short-circuit / no overload" after bus voltage return. Should, after bus voltage return, a short-circuit or an overload occur, then the actuator will start a new identification phase.

After an ETS programming operation, short-circuit / overload signals are always deactivated. Here, in the case of shorted or overloaded valve outputs, the actuator will first perform an identification phase again, in order to detect faulty valve outputs.

- i** The object always transmits the current status after bus voltage return and an ETS programming operation after a delay, providing that a delay after bus voltage return has been configured on the "General" parameter page.

Resetting a short-circuit / overload

Valve outputs, identified as having shorted or being overloaded, are detected by the actuator. In this case, affected valve outputs can no longer be activated by any functions of the actuator. The cause of the error must be eliminated and the "Short-circuit / overload" state also be reset, so that the outputs can be activated again.

Overload / short-circuit states can be reset by switching off the valve voltage supply. The following procedure is required for this:

a) Switch-off of the valve voltage supply. This means that all the overload / short-circuit signals of the valve outputs are reset immediately. If, at this time, no bus voltage is switched on, then the actuator will reset the overload / short-circuit signals after the bus voltage is switched on again.

b) Elimination of the cause of the overload / short-circuit

c) Switch-on of the valve voltage supply. The valves can then be activated again normally.

d) Should all or some of the valve outputs still be shorted or overloaded after the return of the valve voltage supply, then a new identification phase will begin.

i Switching off the valve voltage during a testing cycle only causes a reset of existing overload / short-circuit signals. The testing cycle is not cancelled.

4.2.4.2.7 Valve rinsing

To prevent calcification or sticking of a valve which has not been activated for some time, the actuator has an automatic valve rinsing function. Valve rinsing can be executed cyclically or using a bus command, causing the activated valves to run through the full valve stroke for a preset period of time. During valve rinsing, the actuator activates a command value of 100 % without interruption for the affected valve output for half of the configured "Valve rinsing time". For this, the valves open completely. After half the time, the actuator switches to a command value of 0%, causing the connected valves to close completely.

If necessary, the intelligent valve rinsing can be enabled. In so doing, cyclical rinsing using the full stroke is only executed when a defined minimum command value limiting value was not exceeded during actuator operation.

- i** During valve rinsing, the actuator executes the command values "1" (corresponds to "100 %" - open completely) and "0" (corresponds to "0 %" - close completely) for valve outputs configured with a command value data format "Switching (1-bit)". The data format of the KNX command variable inputs is permanently set to "1-bit" for the application program "Heating actuator basic 6-gang 20D111" (version 1.1).
- i** The actuator takes the valve direction of action configured in the ETS into account in the electrical activation of the valve output.

At the end of valve rinsing, the actuator automatic sets the tracked command value according to the priority control (see page 18).

- i** The actuator does not execute valve rinsing if a higher-priority function is active. Nonetheless, the actuator internally starts the rinse length, as soon as the device receives a command for valve rinsing (cyclically or via bus command). If, during an active rinsing time, higher-priority functions are exited, then the actuator will execute the remaining residual time of the rinse function. If the rinsing time continuous to elapse during a function with a higher priority, then there is no residual time. Thus, the actuator will not execute the previously started valve rinsing.
- i** The actuator also executes valve rinsing by starting the rinse time, even if the valve power supply has been switched off. A bus voltage failure immediately interrupts an active rinsing operation. After bus voltage return, a previously interrupted rinsing operation is not executed again.

Valve rinsing possesses a separate 1-bit status object. Optionally, this object can be used, for example, to display a KNX visualisation that valve rinsing is taking place (rinse operation time running). The status telegram can be used, for example, to disable a KNX room temperature controller for the length of the valve rinsing. Particularly in the case of long rinsing times, the disabling of the room temperature controller, possibly in combination with the disabling of the controller operation, can make a positive contribution to the suppression of the oscillation behaviour of the controller.

The telegram polarity of the status object is fixed: "0" = Valve rinsing inactive, "1" = Valve rinsing active.

- i** The object transmits the current status after bus voltage return and after an ETS programming operation without a delay.

Enabling valve rinsing

Valve rinsing can only be used if it has been enabled in the ETS.

- Set the "Use 'Valve rinsing' function ?" parameter on the parameter page "Ax - Valve rinsing" to "Yes". In the "Valve rinsing time" parameter, configure for how long the rinse function (100 % -> 0 %) is to be executed.

Valve rinsing is enabled. Additional parameters become visible in the ETS, presetting whether the valve rinsing is to be activated cyclically and / or with bus control.

- i** Set the length of the valve rinsing to the adjustment cycle time of the electrothermal actuators in such a way that they open and close completely. This is usually guaranteed by configuring the rinsing length to double the adjustment cycle time.
 - Set the "Use 'Valve rinsing' function ?" parameter to "no".
Valve rinsing is not available.

Configuring cyclical valve rinsing

The actuator can perform valve rinsing cyclically, if necessary. When using the cyclical valve rinsing, a rinse operation can be started automatically after a configurable cycle time (1...26 weeks). Here too, the valve rinsing length configured in the ETS defines the time for the once-only, complete opening and closing of the activated valve drives. At the end of a rinsing operation, the actuator always restarts the cycle time.

Valve rinsing must be enabled and a valid rinsing time configured.

- Set the "Activate cyclical valve rinsing ?" parameter to "yes". In the case of the "Cycle time" parameter, configure how often valve rinsing is to be performed automatically.
Cyclical valve rinsing is enabled.
 - Set the "Activate cyclical valve rinsing ?" parameter to "no".
Cyclical valve rinsing is completely disabled. Valve rinsing can only be started by the communication object (if enabled).
- i** Each ETS programming operation resets the cycle time. The first rinsing operation with cyclical valve rinsing takes place after an ETS programming operation after the first time cycle has elapsed.
If there is a bus voltage failure, the actuator saves the remaining residual time of the current time cycle. The residual cycle time is restarted after bus voltage return.
A bus voltage failure immediately interrupts an active rinsing operation. After bus voltage return, a previously interrupted rinsing operation is not executed again. The actuator then starts a new time cycle for cyclical valve rinsing.

Optionally, intelligent cyclical valve rinsing can be additionally activated. Here, valve rinsing is only executed repeatedly, if, in the current time cycle, a minimum command value limiting value, configurable in the ETS, was not exceeded. If the active command value exceeds the limiting value, then the actuator will stop the cycle time. The actuator only restarts the cycle time if, in the further course of the command value change, a command value of "0 %" or "OFF" (completely closed) is set (Figure 20). This prevents valve rinsing if the valve has already run through a sufficiently defined stroke.

If, after exceeding the configured limiting value, the value was not completely closed at least once (command value "0 %" or "OFF"), then no further cyclical valve rinsing will take place.

Use of the intelligent cyclical valve rinsing means that rinsing operations over the entire valve stroke are only then used when this is sensible and actually required. For example, in the summer months, the use of heating power is lower. In consequence, the valves are activated less frequently by command values, meaning that valve rinsing should be performed as anti-sticking protection. In the winter months, it is frequent necessary to activate heating valves using normal command value telegrams.

The intelligent valve rinsing ensures that no redundant valve rinsing is not performed in the winter. In the summer, the intelligent control performs valve rinsing cyclically.

- i** The cycle time is always started after an ETS programming operation. This also occurs when the active command value exceeds the configured limiting value after the download.

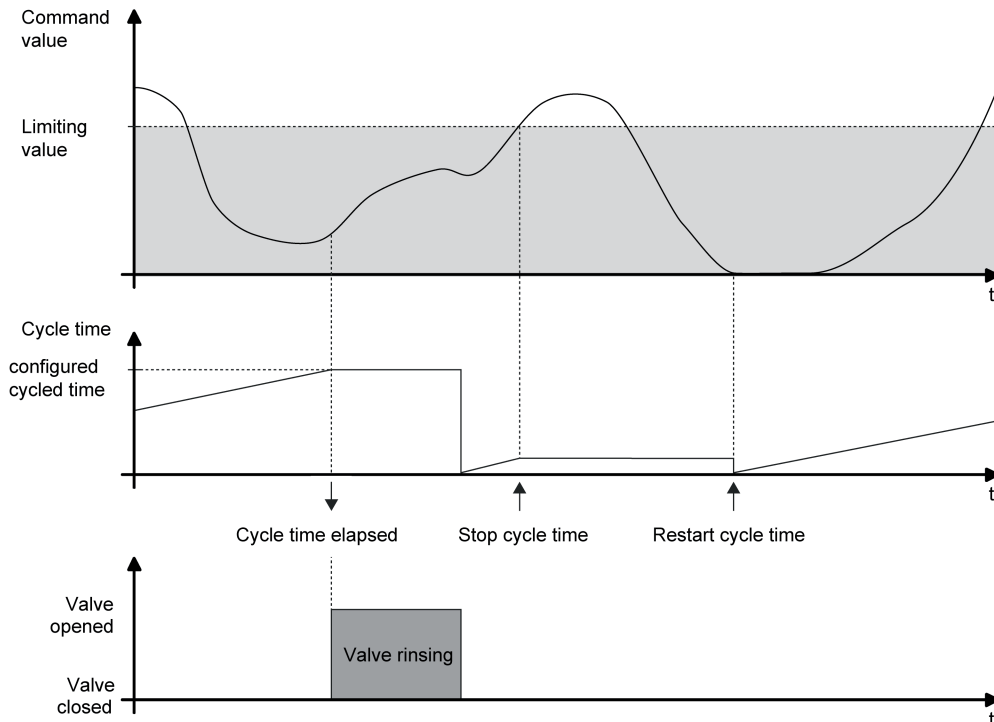

Figure 20: Example of a minimum command value limiting value for intelligent valve rinsing

- Set the "Use intelligent valve rinsing ?" parameter to "yes". Using the "Limiting value minimum command value (10...100 %)" parameter, define the command value limiting value.

Intelligent cyclical valve rinsing is activated. Valve rinsing is only executed when the configured limiting value was exceeded at least once in the previous time cycle and, consequently, the valve was run to the "0 %" command value.

- Set the "Use intelligent valve rinsing ?" parameter to "no".

Intelligent cyclical valve rinsing is deactivated. Valve rinsing always takes place as soon as the set cycle time has expired.

- i
 Valve rinsing can optionally be started and, if required, stopped using a communication object. If valve rinsing was started by the object, then the actuator will stop the cycle time of the cyclical valve rinsing operation. The cycle time is only restarted after the rinsing operation has been fully executed without interruption or a stop command was received via the object.

Configuring bus-controlled valve rinsing via an object

If necessary, valve rinsing can be started and, optionally, stopped using its own 1-bit communication object. This means that it is possible to activate a rinsing operation of the valve controlled by time or an event. It is also possible, for example, to cascade multiple heating actuators, so that they perform valve rinsing simultaneously (link of the individual status objects to the input objects of the valve rinsing).

Bus control can only be used if it has been enabled in the ETS.

Valve rinsing must be enabled and a valid rinsing time configured.

- Set the "Valve rinsing activated externally ?" parameter to "yes". In the case of the parameter "Polarity of 'Start / stop valve rinsing' object", configure the telegram polarity, thus presetting whether the bus-controlled starting and stopping, or, alternatively, only starting, should be possible.

Bus-controlled valve rinsing is enabled. The communication object is visible. The name of the object is aligned to the setting of the permitted telegram polarity ("Start / stop valve rinsing" or "Start valve rinsing"). When a start command is received, the actuator immediately starts the configured time for a rinsing operation. The actuator also actively executes valve rinsing if no higher-priority function is active. If bus-controlled stopping is permitted, then the actuator will also react to stop commands by immediately interrupting running rinsing operations.

- Set the "Valve rinsing activated externally ?" parameter to "no".

Bus-controlled valve rinsing is not available. Valve rinsing can only take place cyclically.

- i** Updates of the object from "Start" to "Start" or "Stop" to "Stop" do not produce a reaction. The length of an elapsing valve rinsing operation or the cycle time of a cyclical valve rinsing operation are not restarted by this.
- i** Bus-controlled valve rinsing via the object can be combined with a cyclical valve rinsing operation. If valve rinsing was started by the object, then the actuator will stop the cycle time of the cyclical valve rinsing operation. The cycle time is only restarted after the rinsing operation has been fully executed without interruption or a stop command was received via the object.

4.2.4.3 Delivery state

In the as-delivered state, the actuator is passive, i.e. no telegrams are transmitted to the bus. All the functions of the actuator are deactivated.

The device can be programmed and put into operation via the ETS. The physical address is preset to 15.15.255

Furthermore, the device has been configured at the factory with the following characteristics (all valve outputs)...

- Valve direction of action: deenergised closed
- Behaviour in case of bus voltage failure: All the valve outputs switch OFF.
- Behaviour after bus voltage return: All the valves close (valve outputs switch OFF).

i The as-delivered state can be restored by unloading the application program with the aid of the ETS. When the application program is removed, all the valve outputs remain permanently switched off.

4.2.5 Parameters

Description	Values	Comment
□- General		
Delay after bus voltage return Minutes (0...59)	0 ...59	To reduce telegram traffic on the bus line after bus voltage switch-on (bus reset), after connection of the device to the bus line or after an ETS programming operation, it is possible to delay active feedback of the actuator. This parameter defines a delay time independent of the channel for this case. Only after the time configured here has elapsed are status or feedback telegrams for initialisation transmitted to the bus, provided that the status and feedback functions are to be transmitted after a delay. Setting the delay time minutes.
	0... 17 ...59	Setting the delay time seconds.
Time for cycl. transmission of feedback Hours (0...23)	0 ...23	The "Command value fault" objects of the valve outputs can, depending on the configuration, also transmit their state cyclically to the bus. The parameter "Time for cyclical transmission of feedback tel." generally defines the cycle time for all valve outputs. Setting the cycle time hours.
Minutes (0...59)	0... 2 ...59	Setting the cycle time minutes.
Seconds (10...59)	10 ...59	Setting the cycle time seconds.
□- Pump		
Activate "Pump control" function ?	no yes	The heating actuator allows switching activation of the circulation pump of a heating or cooling circuit via a 1-bit KNX telegram. Here, the pump control of the actuator can be enabled centrally ("Yes" setting). The valve outputs must be assigned to the pump control individually on the parameter pages "Ax - Assignments", so that they are included in the control.
Polarity of "Pump control" object	0 = Switch off pump / 1 = Switch on pump 0 = Switch on pump/ 1 = Switch off pump	This parameter defines the telegram polarity of the "Pump control" object. It is visible only if the pump control is enabled.

Delay pump ACTIVE Minutes (0...59)	0...59	The actuator only outputs the "Pump ON" telegram after determination when the delay time defined here has elapsed. The pump is not switched on if the actuator no longer determines a requirement within the time preset here. This parameter is visible only if the pump control is enabled. Definition of the delay time minutes.
Seconds (0...59)	0... 10 ...59	Definition of the delay time seconds.
□ Ax - General		
Valve in voltage-free state (Valve direction of action)	closed open	Valve drives that are closed or open when deenergised can be connected. On each electrical activation of the valve outputs, the actuator takes the valve direction of action configured here into account, so that the command value presettings (Valve closed OFF, 0 % / Valve opened ON, 1...100 %) can be executed in the correct direction of action. The valve outputs are no longer energised if the valve voltage supply fails or if there is a short-circuit or overload. The actuator takes this state into account and also influences the command value feedback, according to the configured valve direction of action.
Behaviour after bus voltage failure	Valve output switches OFF	In this case, even if valve voltage is available, the valve output will always switch off when there is a bus voltage failure, as the device electronics are no longer being supplied with energy and, as a result, the actuator is unable to function. In this state of operation, deenergised closed valve drives close completely and deenergised opened valve drives open. The configured valve direction of action can no longer be evaluated if the bus voltage fails.
Behaviour after bus voltage return	Command value 0 % (close valve) Activating command as for emergency operation	After a bus voltage return, the valve outputs perform the configured reaction at this point. After bus voltage return, the valve is closed completely. For the valve output, the actuator polls the emergency operation command value, as configured in the ETS. Ensure that, in this setting, emergency operation is not executed (as would be the case if there was a faulty command value found in the course of command value monitoring)! The actuator only

	<p>Command value as before bus voltage failure</p>	<p>polls the command value preset for emergency operation.</p> <p>After bus voltage return, that command value is set at the valve output which was active at the moment of the last bus voltage failure. If there is a bus voltage failure, the actuator saves the active command value internally in the device, so that the command value can be restored when the device power supply returns. Saving only takes place after a previous device reset (ETS programming operation, bus voltage return) when the reset is longer than 30 seconds previously. Otherwise the actuator does not save the current command value! In that case, an old value remains valid, as was previously saved by the actuator on the bus voltage failure.</p>
<p>Behaviour after ETS programming</p>	<p>Command value 0 % (close valve)</p>	<p>After an ETS programming operation, the actuator always closes the valve completely.</p>
<p>□ Ax - Command value/status/operating mode</p>		<p>The heating actuator receives 1-bit or 1-byte command value telegrams, transmitted, for example, by KNX room temperature controllers. Usually, the room temperature controller determines the room temperature and generates the command value telegrams using a control algorithm. The actuator controls its valve outputs either in switching form or with a PWM signal, according to the data format of the command values and the configuration in the ETS.</p> <p>This parameter is only available with the application program "Heating actuator basic 6-gang 20D112"! When the application program "Heating actuator basic 6-gang 20D111" is used, the data format is permanently set to "1-bit".</p>
<p>Data format of the command value input</p>	<p>Switching (1 bit)</p>	<p>In the case of a 1-bit command value, the telegram received via the command value object is forwarded directly to the appropriate output of the actuator, taking the configured valve direction of action into account. This means that, if an "ON" telegram is received, the valve is completely opened. The output is then energised for energised closed valves and the output is deenergised for energised opened valve drives. The valve is closed completely when an "OFF" telegram is received. The valve</p>

		<p>output is then not energised for deenergised closed valves and energised for deenergised opened valve drives.</p>
	<p>Constantly (1 byte) with pulse width modulation (PWM)</p>	<p>Command values corresponding to the data format "Constant 1-byte with pulse width modulation (PWM)" are implemented by the actuator with an equivalent pulse width-modulated switch signal at the valve outputs. Taking the cycle time settable in the actuator for each output into account, the average output signal resulting from this modulation is a measure of the centred valve position of the control valve and thus a reference for the set room temperature. A shift of the mean value, and thus a change in the heating capacity, can be obtained by changing the duty factor of the switch-on and switch-off pulses of the output signal. The duty factor is adapted constantly by the actuator, depending on the command value received (normal operation) or by active device functions (e.g. manual operation, forced position, emergency operation).</p>
<p>Cycle time for continuous command value on the valve output</p>	<p>0.5 minutes 1 minute 1.5 minutes 2 minutes ... 19.5 minutes 20 minutes (recommended)</p>	<p>The "Cycle time" parameter specifies the switching frequency of the pulse-width-modulated output signal of a valve output. It allows adaptation to the adjusting cycle times (the adjusting time it takes the drive to bring the valve from its completely closed to its completely opened position) of the actuators used. In addition to the adjusting cycle time, take account of the dead time (the time in which the actuators do not show any response when being switched or off). If different actuators with different adjusting cycle times are used at an output, take account of the longest of the times.</p> <p>The "Cycle time" parameter is also available for valve drives, whose command value data format is configured to "Switching (1-bit)". For such valve outputs, pulse width modulation can also be executed during an active emergency operation or after bus voltage return, for which, as a result, the presetting of a cycle time is required. This parameter is only available with the application program "Heating actuator basic 6-gang 20D112"!</p>
<p>Cycle time for continuous "Emergency operation" command</p>	<p>0.5 minutes 1 minute 1.5 minutes 2 minutes</p>	<p>This parameter specifies the switching frequency of the pulse width-modulated output signal of a valve output, should the configured emergency operation</p>

value at the valve output	... 19.5 minutes 20 minutes (recommended)	command value be recalled. The parameter allows adaptation to the adjusting cycle times (the adjusting time it takes the drive to bring the valve from its completely closed to its completely opened position) of the actuators used. In addition to the adjusting cycle time, take account of the dead time (the time in which the actuators do not show any response when being switched or off). If different actuators with different adjusting cycle times are used at an output, take account of the longest of the times. This parameter is only available with the application program "Heating actuator basic 6-gang 20D111"!
Activate command value monitoring ?	no yes	Here, cyclical monitoring of the command values can be enabled as an option ("Yes" setting). If, in active cyclical monitoring, there are no command value telegrams during the monitoring time preset by the parameter of the same name, then emergency operation is activated for the affected valve output, for which a configurable constant PWM command value can be preset.
Monitoring time Minutes (0...59)	0... 10 ...59	This parameter specifies the monitoring time of the command value monitoring. The actuator must receive at least one command value telegram within the time frame specified here. If there is no command value telegram, then the actuator will assume a fault and will activate emergency operation for the affected valve output. This parameter is only available if command value monitoring is enabled.
Seconds (10...59)	10 ...59	presetting of the monitoring time seconds.
Polarity of "Command value fault" object	0 = No fault / 1 = Fault 0 = Fault / 1 = No fault	If a command value fault is identified, then the actuator can optionally transmit a fault telegram via the object "Command value fault". This parameter defines the telegram polarity of the fault telegram. This parameter is only available if command value monitoring is enabled.

<p>Cyclical transmission in the case of faulty command value ?</p>	<p>no yes</p>	<p>If a command value fault is identified, then the actuator can optionally transmit the fault telegram cyclically. Here, the cyclical transmission of the fault telegram can be enabled as required ("Yes" setting). This parameter is only available if command value monitoring is enabled.</p>
<p>Command value in the case of emergency operation</p>	<p>0 % 10 % ... 30 % ... 90 % 100 %</p>	<p>When a fault in the input command value is detected and also in the case of a bus voltage return (configurable), it is possible to set the emergency operation command value configured here as the active command value. When the emergency operation command value is recalled, valve outputs are always activated by pulse width modulation.</p>
<p>Signalling short-circuit / overload ?</p>	<p>no yes</p>	<p>The actuator is able to detect an overload or a short-circuit at the valve outputs and, in consequence, to protect them against destruction. Outputs which have experienced a short-circuit or a constant load are deactivated after an identification period. In this case, a short-circuit or overload signal can be transmitted via a KNX communication object. In the "Yes" setting, this parameter enables the object "Short-circuit / overload signal".</p>
<p>Polarity of object "Short-circuit / overload"</p>	<p>0 = No short-cir, overl. / 1 = Short-cir, overl.</p> <p>0 = Short-cir, overl. / 1 = No short-cir, overl.</p>	<p>When the object for short-circuit / overload messaging is enabled, the telegram polarity of the "Short-circuit / overload signal" object is defined here.</p>
<p><input type="checkbox"/> Ax - Valve rinsing</p> <p>Use function "Valve rinsing" ?</p>	<p>no yes</p>	<p>To prevent calcification or sticking of a valve which has not been activated for some time, the actuator has an automatic valve rinsing function. Valve rinsing can be executed cyclically or using a bus command, causing the activated valves to run through the full valve stroke for a preset period of time. During valve rinsing, the actuator activates a command value of 100 % without interruption for the affected valve output for half of the configured "Valve rinsing time". For this, the valves open completely. After half the time, the</p>

		actuator switches to a command value of 0%, causing the connected valves to close completely. In the "Yes" setting, this parameter enables valve rinsing.
Length of valve rinsing (1...59 minutes)	1...5...59	Here, preset for how long the rinse function (100 % -> 0 %) is to be executed. Set the length of the valve rinsing to the adjustment cycle time of the electrothermal actuators in such a way that they open and close completely. This is usually guaranteed by configuring the rinsing length to double the adjustment cycle time. This parameter is only available if valve rinsing is enabled.
Activate cyclical valve rinsing ?		The actuator can perform valve rinsing cyclically, if necessary. When using the cyclical valve rinsing, a rinse operation can be started automatically after a configurable cycle time (1...26 weeks). Here too, the valve rinsing length configured in the ETS defines the time for the once-only, complete opening and closing of the activated valve drives. At the end of a rinsing operation, the actuator always restarts the cycle time. This parameter is only available if valve rinsing is enabled.
	yes	Cyclical valve rinsing is enabled. Each ETS programming operation resets the cycle time. The first rinsing operation with cyclical valve rinsing takes place after an ETS programming operation after the first time cycle has elapsed. If there is a bus voltage failure, the actuator saves the remaining residual time of the current time cycle. The residual cycle time is restarted after bus voltage return. A bus voltage failure immediately interrupts an active rinsing operation. After bus voltage return, a previously interrupted rinsing operation is not executed again. The actuator then starts a new time cycle for cyclical valve rinsing.
	no	Cyclical valve rinsing is completely disabled. Valve rinsing can only be started by the communication object (if enabled).
Cycle time (1...26 weeks)	1...26	This parameter defines how often cyclical valve rinsing is to be performed automatically.

			This parameter is only available if cyclical valve rinsing is enabled.
Use intelligent valve rinsing ?	no yes		Optionally, intelligent cyclical valve rinsing can be additionally activated here. Here, valve rinsing is only executed repeatedly, if, in the current time cycle, a configured minimum command value limiting value was not exceeded. If the active command value exceeds the limiting value, then the actuator will stop the cycle time. The actuator only restarts the cycle time if, in the further course of the command value change, a command value of "0 %" or "OFF" (completely closed) is set . This prevents valve rinsing if the valve has already run through a sufficiently defined stroke. If, after exceeding the configured limiting value, the value was not completely closed at least once (command value "0 %" or "OFF"), then no further cyclical valve rinsing will take place. This parameter is only available if cyclical valve rinsing is enabled.
Limiting value minimum command value (10...100 %)	10... 50 ...100		This parameter defines the minimum command value limiting value of the intelligent valve rinsing. Intelligent valve rinsing is only executed repeatedly, if, in the current time cycle, a minimum command value limiting value configured here was not exceeded. If the active command value exceeds the limiting value, then the actuator will stop the cycle time. This parameter is only available if cyclical valve rinsing is enabled.
Valve rinsing activated externally ?	no yes		If necessary, valve rinsing can be started and, optionally, stopped using its own 1-bit communication object. This means that it is possible to activate a rinsing operation of the valve controlled by time or an event. It is also possible, for example, to cascade multiple heating actuators, so that they perform valve rinsing simultaneously (link of the individual status objects to the input objects of the valve rinsing). Bus control can only be used if it has been enabled here. This parameter is only available if valve rinsing is enabled.

Polarity of object "Valve rinsing Start / Stop" **0 = Stop / 1 = Start**

0 = Start / 1 = Stop

0 = --- / 1 = Start (Stop not possible)

This parameter sets the telegram polarity of the object for external valve rinsing. The name of the object is aligned to the setting of the permitted telegram polarity ("Start / stop valve rinsing" or "Start valve rinsing"). When a start command is received, the actuator immediately starts the configured time for a rinsing operation. The actuator also actively executes valve rinsing if no higher-priority function is active. If bus-controlled stopping is permitted, then the actuator will also react to stop commands by immediately interrupting running rinsing operations.

☐ Ax - Assignments

Assignment to the function "Pump control" no
? **yes**

The heating actuator allows switching activation of the circulation pump of a heating or cooling circuit via a 1-bit KNX telegram. Pump control is a global function of the heating actuator. It is enabled and configured on the "Pump" parameter page. The parameter "Assignment to the function 'Pump control' ?" specifies whether the appropriate valve output is included in the pump control.

The presetting of the parameter depends on the enabling function of the function. If pump control is not enabled on the "Pump" parameter page, then the ETS will permanently set this parameter to "No". In this case, assignment is not possible. If pump control is enabled, this parameter is preset to "Yes".

5 Appendix

5.1 Index

A	
as-delivered state.....	43
C	
cycle time.....	28
E	
ETS search paths.....	12
I	
intelligent valve rinsing.....	41
O	
overload.....	33
P	
pump controller.....	19
S	
Safe-state mode.....	14
short-circuit.....	33
T	
Testing cycle.....	33
V	
valve direction of action.....	21
valve rinsing function.....	39

Gira
Giersiepen GmbH & Co. KG
Elektro-Installations-
Systeme

Industriegebiet Mermbach
Dahlienstraße
42477 Radevormwald

Postfach 12 20
42461 Radevormwald

Deutschland

Tel +49(0)21 95 - 602-0
Fax +49(0)21 95 - 602-191

www.gira.de
info@gira.de