

Operating Instructions  
System Manual

**Audio control device**  
1287 00

**GIRA**



## Table of contents

---

System information.....	4
Installation scenario topologies.....	6
Structure of a door station .....	8
Structure of a home station .....	10
The door communication bus coupler .....	12
The audio control device.....	14
Displays and operating elements of audio control device .....	15
Connection terminals of audio control device .....	17
Mounting of audio control device.....	18
Technical data of audio control device .....	18

## Start-up

Switching system to programming mode .....	19
One-family house: Assigning door station call button to home station.....	20
House divided into several flats: Assigning door station call buttons to home stations	
21	
Assigning door opener.....	23
Automatic door opener .....	25
Assigning home station via floor-call button .....	27
Assigning several home stations to a call button .....	28
Assigning several home stations to a floor-call button .....	29
Assigning call button for home station to a home station (internal call).....	30
Deleting all assignments to a home station .....	31
Deleting assignment of the door opener .....	32
Replacement of defective call button top units of a flush-mounted door station .....	33
LED indicators on BUS devices .....	34
Acknowledgement tones of Bus devices.....	35
Table for start-up documentation.....	36
Acceptance of guarantee.....	38

The Gira door communication system operates with the voltage type SELV.

With the audio control device, systems with up to 70 audio devices can be realised in certain systems, e.g. 1 built-in speaker with 5 add-on modules and 68 surface-mounted hands-free feature home stations.

Depending on the system size, a maximum of 3 home stations can be operated in parallel per call button



### Planning software

An exact determination of the maximum system size is possible with the planning software at [www.gira.de](http://www.gira.de).

A call-tone differentiation is made between the following calls at the home stations:

- door call (initiated by call button)
- floor call (initiated by floor-call button)
- internal call (initiated by call button for home stations)

### Cabling and cable arrangement

Cables with a wire diameter of 0.6 or 0.8 mm can be used as bus lines.

The following cable types are suitable for use as bus lines:

- J-Y(ST)Y (communication line)
- YR (insulated bell wiring)
- A-2Y(L)2Y (communication cable)

### **Cable lengths for audio components**

The maximum total cable length (distributed among several wiring sections) is 700 m.

A maximum of 30 devices may be connected to each wiring section.

The maximum cable lengths of the individual sections (from the control device to the last device) are dependent on the cable diameter used. The guidelines for audio components are:

- 0.6 mm diameter: 170 m,
- 0.8 mm diameter: 300 m.

## "Branch line" solution

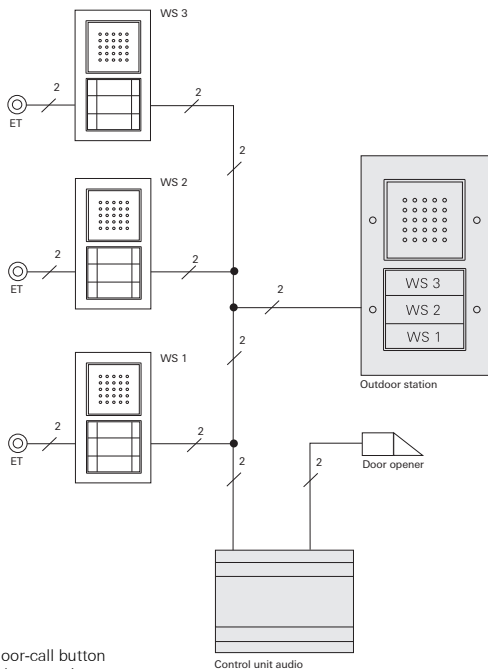

## "Loop-through" solution

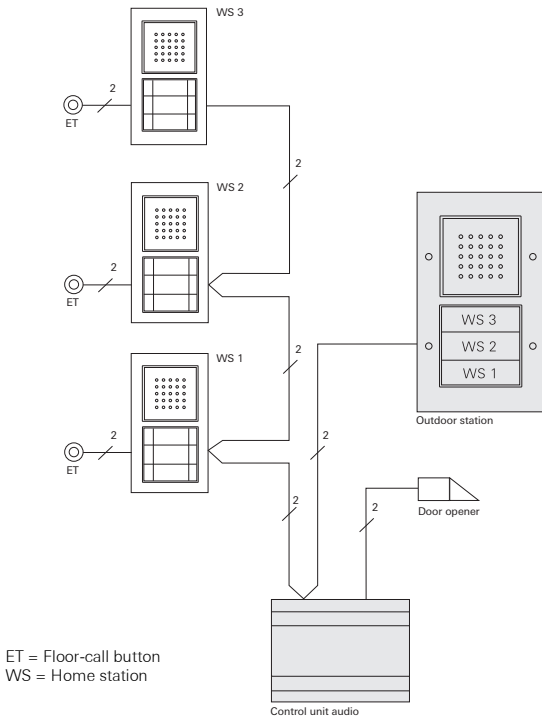

The "loop-through" solution has the advantage of not requiring the installation of a video distributor should video components be retrofitted at a later time.

## Structure of a flush-mounted door station

---

The basic structure of a flush-mounted door station is presented in the example of the flush-mounted door station with 3-gang call button.

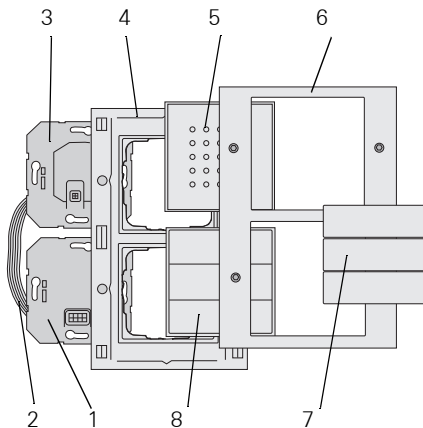

- 1 Door communication bus coupler
- 2 Audio connection cable
- 3 Speech insert
- 4 TX\_44 cover frame bottom section  
(not in scope of supply)
- 5 Door speaker top unit
- 6 TX\_44 cover frame top section  
(not in scope of supply)
- 7 Call-button cover plates
- 8 3-gang call button



## Structure of a surface-mounted door station

---

The basic structure of a surface-mounted door station is presented in the example of the surface-mounted door station with 3-gang call button.

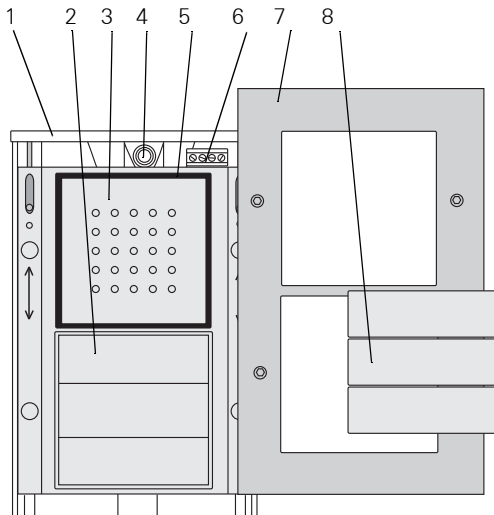

- 1 Housing, bottom section
- 2 3-gang call button
- 3 Speech cover plate
- 4 Cable inlet
- 5 Sealing ring
- 6 Connection terminals
- 7 Housing, top section
- 8 Call-button cover plates

## Structure of a flush-mounted home station

---

The basic structure of a flush-mounted home station is presented in the example of the Comfort home station with receiver.

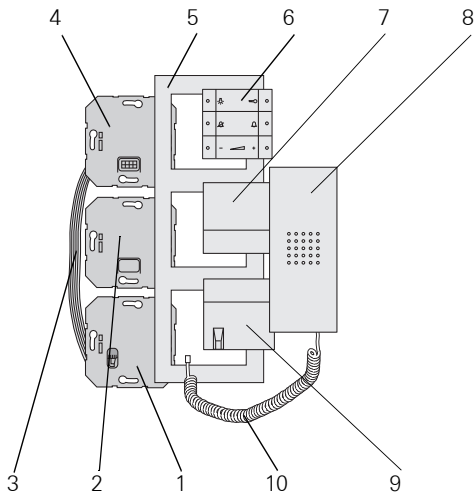

- 1 Receiver insert
- 2 Empty insert
- 3 Audio connection cable
- 4 Door communication bus coupler
- 5 Cover frame (not included in scope of supply)
- 6 Operating buttons
- 7 Receiver mount
- 8 Receiver
- 9 Receiver mount with cable branch
- 10 Receiver cable

## Structure of the surface-mounted hands-free feature home station

The structure of the surface-mounted hands-free feature home station is shown in the following example.

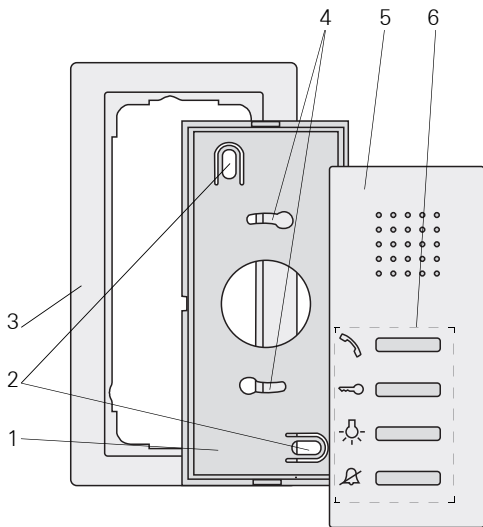

- 1 Mounting plate
- 2 Fixing holes for wall mounting
- 3 2-gang cover frame without crossbar  
(cover frame not included in scope of supply, frameless installation only possible with wall mounting)
- 4 Fixing holes for box mounting
- 5 Housing, top section
- 6 Operating buttons

## Door communication bus coupler

---

The flush-mounted versions of the door and home stations are connected to the 2-wire bus via door-communication bus couplers.

The bus coupler has the following connections:

### **BUS**

The devices are connected to the 2-wire bus via the BUS terminals. Polarity need not be taken into account during connection, as the polarity of the door communication bus is neutral.

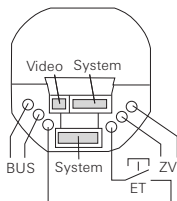

### **Floor-call button (ET)**

With home stations, any push button (NO contact) can be connected to the ET terminals as the floor-call button.

With the door stations, for example, a mechanical bell button (NO contact) can be connected. This then acts like a call button from the Gira door communication system during start-up and later operation.

The maximum cable length between the mechanical button and the door-communication bus coupler is 20 m.

## Additional supply (ZV)

The ZV terminals have two functions:

1. Power supply of call button illumination at the door stations.  
The call buttons are constantly illuminated at the door stations. If the call button illumination is to be switched off permanently, the jumpers between the bus and ZV terminal must be removed.
2. Additional power supply for bus devices which can no longer be powered via the 2-wire bus.



### Connecting an additional power supply

If an additional power supply is connected to the ZV terminals, the jumpers must be removed.

## System

The flush-mounted inserts are connected to each other with the 6-pole audio connection cable via these connectors.

## Video

The door communication bus coupler is connected to the flush-mounted inserts of the video devices, e.g. TFT colour display, colour camera etc., via the 2-pole connector.



### Rubber plugs in the connectors

The "second" connectors are sealed with rubber plugs. These plugs can be removed if necessary.

## The audio control device

---

The audio control device is the main power supply of the Gira door communication system.

The audio control device assumes the following tasks in the Gira door communication system:

- provision of the bus voltage (26 V DC  $\pm$  2 V) for the door communication system.
- power supply of call button illumination (max. 15, the number of call button illuminations that can be supplied is dependent on the system size and the number of home stations operation in parallel).
- provision of door opener control, including power supply (12 V AC, 1.6 A) of the door opener.
- power supply of a TC-gateway.
- activation of the programming mode from the entire door communication bus system.

Additional product features of the control device:

- maximum of 70 devices, e.g.
  - 1 built-in speaker with 5 add-on modules,
  - 68 surface-mounted home stations.
- depending on the system size, up to 3 home stations can be operated.
- electronic overload and short-circuit protection.
- electronic excess-temperature protection.
- overload/short-circuit LED indicator.
- LED operation indication for determination of whether or not mains voltage is active.
- adjustable activation time of door opener.

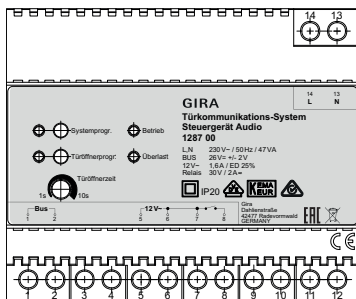

### "Systemprog." button

By pressing the "Systemprog." button (for 3 s) the door communication system is switched into the programming mode. The yellow LED next to the programming button indicates the active programming mode via flashing (see Page 19).

### "Türöffnerprog." button

The "Türöffnerprog." button has two functions:

1. Activating door-opener programming mode:  
If the "Türöffnerprog." button is pressed for 3 seconds while the system is in programming mode, the door-opener programming mode is activated (see Page 23).  
The yellow LED next to the "Türöffnerprog." button indicates the active door-opener programming mode via flashing.
2. Actuation of the connected door opener.  
Briefly pressing the "Türöffnerprog." button activates the door opener for the set time (Türöffnerzeit). The yellow LED next to the "Türöffnerprog." button illuminates during the switching time.

### **"Türöffnerzeit" adjuster**

The activation time of the door opener is set at the "Türöffnerzeit" adjuster. The setting time lies in the range 1 second to 10 seconds. The potentiometer can be adjusted with a screwdriver with a 3 mm blade.

### **"Betrieb" indicator**

During trouble-free normal operation, only the green "Betrieb" LED illuminates. It indicates that the device is being supplied with power.

### **"Überlast" indicator**

The audio control device is equipped with an electronic overload protection which protects the electronics of the control device against short-circuits and overloading on the bus line.

The overload protection is activated if, for example, the bus line is short-circuited due to an installation error or too many bus devices/bus loads are connected.

The red "Überlast" LED indicates both short-circuits and overloads. The flashing duration of the LED corresponds to the time during which the bus voltage is deactivated when a fault occurs. The LED then flashes for up to 20 seconds after the fault has been eliminated.

With a permanent overload (or short-circuit), the bus voltage is switched off for approx. 180 s after the third overload detection. During this switch-off phase, the "Systemprog.", "Türöffnerprogr." and "Überlast" LEDs flash.

The LEDs then flash for up to 180 seconds after the fault has been eliminated.



## Connection terminals of audio control device

---

### L, N

Mains connection terminals L and N (AC 230 V, 50 Hz).

### Bus

Output for powering of the Gira door communication bus with regulated direct current (26 V DC  $\pm$  2 V, 160 mA).

### 12 V AC

The 12 V AC output is used to supply power to the door opener (power consumption of the door opener is max. 1.6 A) or the telecommunication gateway.

### Door opener relay

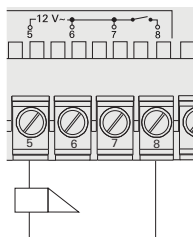

Relay output for operating a door opener (8 - 12 V AC, max. 1.6 A).

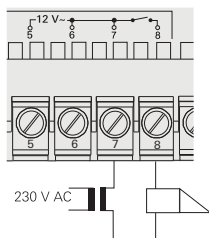

A door opener with other electrical values (e.g. very low-ohm or 24 V) can be connected to the relay contact with an additional power supply.

## Mounting of audio control device

---



### Attention

Installation and mounting of electrical devices may only be carried out by a qualified electrician.

For installation protected from dripping and sprayed water, mount the control device to a top-hat rail in the distribution. The mains and bus connection is made via screw terminals. The mains connection must be made via an all-pole mains switch with at least a 3 mm contact opening. The ventilation slits of the control device must not be blocked.

## Technical data of audio control device

---

Primary rated voltage:	AC 230 V, 50 Hz
Secondary rated voltage:	SELV 26 V DC $\pm$ 2 V
Secondary rated current:	160 mA continuous load Overload deactivation from approx. 350 mA 550 mA peak load (max. 5 seconds)
Power:	47 VA
Protection type:	IP 20
Screw terminals:	0.6 mm $\varnothing$ to 2.5 mm <sup>2</sup>
door opener output:	12 V AC, 1.6 A
Power-on time door opener:	25% (max. 10 seconds ON, then 30 seconds OFF)
Contact load capacity (relay output):	30 V AC, 2 A
Door opener time:	adjustable, 1 to 10 seconds
Operating temperature:	- 5 °C to + 45 °C
Dimensions:	6 modules, series inst. housing

## Switching system to programming mode

---

The Gira door communication system is switched to programming mode for start-up:



1. Press the "Systemprog." button on the **control device** for 3 seconds.

✓ The yellow LED next to the programming button flashes (flash frequency: 1 Hz) after the button is pressed and indicates the active programming mode.

The system is now in programming mode for approx. 7 minutes. Each time the start-up button is pressed on a door or home station, the time is reset to approx. 7 minutes.



### LED indicators on BUS devices

The active programming mode is also signalled by the LED of various BUS devices, such as the hands-free feature home station, the Comfort home station with receiver or the surface-mounted hands-free feature home station.

An overview of the LED indication is found on Page 34.



### Exiting programming mode

1. Briefly press the "Systemprog." button on the **control device** to exit the programming mode.

✓ The yellow LED goes out.

### Start-up documentation

For documentation on the home stations assigned to the call buttons, please see the table on Page 36.

There you enter the names/homes in the sequence in which you will allocate the home stations later on.

## One-family house: Assigning door station call button to home station

To assign a door station call button to a home station, proceed as follows:



1. Press the "Systemprog." button on the **control device** for 3 seconds to start programming mode (see Page 19).
2. Press the call button on the **door station** for 3 seconds until you hear a short acknowledgement tone.



- ✓ You will hear a long acknowledgement tone.



### Releasing the button after 3 seconds

If the button press is not ended after the first acknowledgement tone, all assignments of the respective door/home station will be deleted after an additional 3 seconds.



3. Press the button on the **home station** for 3 seconds until you hear a short acknowledgement tone.

- ✓ A long acknowledgement tone indicates successful assignment.

Three short acknowledgement tones indicate faulty assignment. The memory of the home station may already be occupied. A maximum of 10 call buttons can be assigned to a home station (a maximum of 15 call buttons to a surface-mounted hand-free feature home station).



4. Press the "Systemprog." button on the **control device** to exit the programming mode.
5. Carry out a function test.

## House divided into several flats:

### Assigning door station call buttons to home stations

---

To assign the door-station call buttons to the respective home stations, please proceed as follows:



1. Press the "Systemprog." button on the **control device** for 3 seconds to start programming mode (see Page 19).



2. Press the call buttons on the **door station** for 3 seconds until you hear a short acknowledgement tone.

**Important:** Press the call buttons in the sequence in which the home stations will be assigned later.



- ✓ You will hear a long acknowledgement tone.



#### Releasing the button after 3 seconds

If the button press is not ended after the first acknowledgement tone, all assignments of the respective door/home station will be deleted after an additional 3 seconds.



3. Go to the **home station** whose call button is the **first** one you pressed at the door station. Press the  button on this **home station** for 3 seconds until you hear a short acknowledgement tone.



- ✓ A long acknowledgement tone indicates successful assignment. Three short acknowledgement tones indicate faulty assignment. The memory of the home station may already be occupied. A maximum of 10 call buttons can be assigned to a home station (a maximum of 15 call buttons to a surface-mounted hand-free feature home station).



4. Go to the **home station** whose call button is the **second** one you pressed at the door station.

Press the  button on this **home station** for 3 seconds until you hear a short acknowledgement tone.



- ✓ A long acknowledgement tone indicates successful assignment.



5. Go to the other **home stations** and press the  button there for 3 seconds until you hear a short acknowledgement tone.



- ✓ A long acknowledgement tone indicates successful assignment.



6. After you have assigned all the home stations, press the "Systemprog." button on the **control device** to exit programming mode.

7. Carry out a function test.



### Maximum number of call buttons per step

Up to 20 call buttons can be temporarily stored per step. If more than 20 call buttons are to be assigned, the first 20 call buttons must first be pressed and then assigned to the home stations. The remaining call buttons can then be assigned.

## Assigning door opener

The door opener connected to the control device is assigned to the "main" door station. It is activated if the ☞ button at a home station is pressed spontaneously, even without any previous conversation.

The door opener of a "back/side" door is connected to the switching actuator. It can be activated via the ☞ button if a door call was previously initiated from the door station of a "back/side" door. It is switched to the "main" door 2 minutes after the door call or 30 seconds after the door call.

### Assigning door opener of "main" door

The door opener connected to the control device is programmed at the respective door station as follows:



1. Press the "Systemprog." button on the **control device** for 3 seconds to start programming mode (see Page 19).
2. Press the "Türöffnerprog." button on the **control device** for 3 seconds to start the door-opener programming mode.
  - ✓ The LED next to the "Türöffnerprog." button flashes.
3. Press any call button on the **door station** for 3 seconds until you hear a short acknowledgement tone.
  - ✓ A long acknowledgement tone confirms successful assignment. In addition, the door opener connected to the control device is operated for the set time.

To assign additional door stations to the door opener (maximum of 3), repeat Step 3 on the next door station.



4. Press the "Türöffnerprog." button on the **control device** to exit door opener programming mode.
5. Press the "Systemprog." button on the **control device** to exit the programming mode.

## Assigning door opener of a "side/back" door

The door opener connected to the switching actuator is programmed at the respective door station as follows:



1. Press the "Systemprog." button on the **control device** for 3 seconds to start programming mode (see Page 19).



2. Briefly press the "Funktion" button on the **switching actuator** several times until the "Door opener" LED flashes.



3. Press the "Prog." button on the **switching actuator** for 3 seconds until the yellow LED next to the "Prog." button flashes.



4. Press any call button on the **door station** for 3 seconds until you hear a short acknowledgement tone.



### Releasing the button after 3 seconds

If the button press is not ended after the first acknowledgement tone, all assignments of the respective door/home station will be deleted after an additional 3 seconds.



✓ A long acknowledgement tone confirms successful assignment. The door opener is controlled for the set time.

To assign additional door stations to the same door opener, repeat Step 4 at the next door station.



5. Briefly press the "Prog." button on the **switching actuator** to exit the programming mode of the switching actuator.

✓ The LED of the "Prog." button goes out. The LED of the last selected function (here "Door opener") continues to flash until programming mode at the control device is exited.



6. Press the "Systemprog." button on the **control device** to exit the programming mode.





### Hands-free feature and Comfort home station

The function "automatic door opener" is only supported by the hands-free feature home station and the Comfort home station with receiver.

The automatic door opener is, for example, used in doctor's offices when after pressing a door-station call button, the door opener is to be automatically operated. With the automatic door opener activated, the door opener assigned to the calling door station is operated approx. 4 seconds after the door call is triggered. If several door stations are present in the system, the automatic function automatically acts on the door opener of the door station from which the door call was triggered.



Before use, the automatic door opener must first be enabled:

### Enabling/disabling "automatic door opener" function

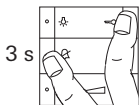

1. Press the "Systemprog." button on the **control device** for 3 seconds to start programming mode (see Page 19).



2. Simultaneously press the buttons  and  on the **home station** for approx. 3 seconds. By pressing these buttons you can switch over the status of the automatic door opener (enabled or disabled)

✓ If the  LED lights up **long** for confirmation, the "automatic door opener" function is **enabled**.

If the  LED lights up **short** for confirmation, the "automatic door opener" function is **disabled**.





3. Press the "Systemprog." button on the **control device** to exit the programming mode.

If the "automatic door opener" function is enabled, you can activate the automatic door opener as necessary on the home station as follows:

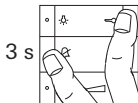

### Activating automatic door opener

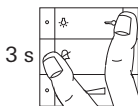

1. Simultaneously press the buttons  and  on the **home station** for approx. 3 seconds to activate the automatic door opener.
- ✓ When the automatic door opener is activated, the LED  lights up continuously. The door opener is automatically operated after a door-station call button is pressed.

### Deactivating automatic door opener



1. Simultaneously press the buttons  and  on the **home station** for approx. 3 seconds to deactivate the automatic door opener.
- ✓ The  LED goes out. The automatic door opener is no longer active.



#### Behaviour after a power failure

The enabled status of the automatic door opener is retained after a power failure.

In this case, the automatic door opener is deactivated for security reasons and must be reactivated if necessary.

## Assigning home station via floor-call button

If you cannot access the home during start-up, you can also assign the home station via a connected floor-call button:



1. Press the "Systemprog." button on the **control device** for 3 seconds to start programming mode (see Page 19).



2. Press the call button to be assigned to the home station on the **door station** for 3 seconds until you hear a short acknowledgement tone.



✓ You will hear a long acknowledgement tone.



3. Go to the **floor-call button of the home station** to be assigned.

Press the floor-call button for 3 seconds until you hear a short acknowledgement tone.



✓ A long acknowledgement tone indicates successful assignment.



### Only possible with directly connected home station

With several parallel home stations, only the home station connected directly to the floor-call button can be taught in via the floor call button.



4. Press the "Systemprog." button on the **control device** to exit the programming mode.

## Assigning several home stations to a call button

If several home stations are to be called simultaneously when a door station call button is pressed, a call button can be assigned to several home stations as follows:



1. Press the "Systemprog." button on the **control device** for 3 seconds to start programming mode (see Page 19).



2. Press the call button to which the home stations are to be assigned at the **door station** for 3 seconds until you hear a short acknowledgement tone.



- ✓ You will hear a long acknowledgement tone.



3. Go to the **first home station**. Press the button for 3 seconds until you hear a short acknowledgement tone.



- ✓ A long acknowledgement tone indicates successful assignment.



4. Go to the **door station** and press the call button again for 3 seconds.



5. Go to the **second (parallel) home station**. Press the button for 3 seconds until you hear a short acknowledgement tone.



- ✓ A long acknowledgement tone indicates successful assignment.

6. Repeat Steps 4 and 5 to assign an additional parallel home station to the call button.



7. Press the "Systemprog." button on the **control device** to exit the programming mode.

8. Carry out a function test.

## Assigning several home stations to a floor-call button

If several home stations are to be called simultaneously when a floor call button is pressed, a floor call button can be assigned to several home stations as follows:



1. Press the "Systemprog." button on the **control device** for 3 seconds to start programming mode (see Page 19).
  2. Press the floor call button connected to **home station 1** for 6 seconds.  
You will hear a brief acknowledgement tone after 3 seconds. Hold down the button for another 3 seconds until you hear a long acknowledgement tone.
  3. Press the  button on **home station 2** for 3 seconds until you hear a short acknowledgement tone.
- ✓ A successful teach-in is confirmed by a long acknowledgement tone at home station 2.

To assign an additional home station, repeat the procedure from Step 2.

4. Briefly press the "Systemprog." button on the **control device** to exit the programming mode.
5. Carry out a function test. All assigned home stations ring when the floor-call button is pressed.



### Do not connect floor-call button in parallel

A floor-call button may not be connected to several home stations in parallel.

## Assigning call buttons for home station to a home station (internal call)

You can implement the so-called internal call function with the optional call button for home stations. A voice connection between two home stations can be established via the internal call.

To assign the call button of a home station to another home station (e.g. in the hobby room), proceed as follows:



1. Press the "Systemprog." button on the **control device** for 3 seconds to start programming mode (see Page 19).



2. Press the call button on **home station 1** for 3 seconds until you hear a short acknowledgement tone.



- ✓ You will hear a long acknowledgement tone.



### Releasing the button after 3 seconds

If the button press is not ended after the first acknowledgement tone, all assignments of the respective door/home station will be deleted after an additional 3 seconds.



3. Press the button on **home station 2** for 3 seconds until you hear a short acknowledgement tone.



- ✓ A long acknowledgement tone indicates successful assignment.

Three short acknowledgement tones indicate faulty assignment. The memory of the home station may already be occupied. A maximum of 10 call buttons can be assigned to a home station (a maximum of 15 call buttons to a surface-mounted hand-free feature home station).



4. Press the "Systemprog." button on the **control device** to exit the programming mode.

5. Carry out a function test.

## Deleting all assignments to a home station

A home station which has already been assigned is deleted as follows:



1. Press the "Systemprog." button on the **control device** for 3 seconds to start programming mode (see Page 19).



2. Press the  button on the **home station** for which the assignment is to be deleted for 6 seconds. You will hear a brief acknowledgement tone after 3 seconds. Hold down the button for another 3 seconds until you hear a long acknowledgement tone.



- ✓ The long acknowledgement tone confirms the successful deletion.



3. Press the "Systemprog." button on the **control device** to exit the programming mode.



### Deletion only possible directly

Deleting the assignment of a call button to a home station is not possible via the floor-call button. The deletion of the assignment can only occur via the  button of the home station.

### Door opener at audio control device

To delete an existing assignment between the door opener connected at the control device and the door station, proceed as follows:



1. Press the "Systemprog." button on the **control device** for 3 seconds to start programming mode (see Page 19).
2. Press the "Türöffnerprog." button on the **control device** for 6 seconds to delete all of the assignments from the control device to the door stations.  
The LED starts flashing after 3 seconds. Keep the button pressed for an additional 3 seconds, until the LED next to the programming button "Türöffnerprog." flashes rapidly.
3. Press the "Systemprog." button on the **control device** to exit the programming mode.

### Door opener at switching actuator

To delete an existing assignment between the door opener connected at the switching actuator and the door station, proceed as follows:



1. Press the "Systemprog." button on the **control device** for 3 seconds to start programming mode (see Page 19).
2. Press the "Prog." button on the **switching actuator** for 6 seconds to delete all of the assignments from the switching actuator to the door stations.  
The LED starts flashing after 3 seconds. Keep the button pressed for an additional 3 seconds, until the LED next to the programming button "Prog." flashes rapidly.
3. Press the "Systemprog." button on the **control device** to exit the programming mode.



## Replacement of defective call button top units of a flush-mounted door station

You can replace defective door station call button top units at a flush-mounted door station without having to reprogram all assignments:



1. Replace all defective call button top units with new ones.
  2. Press the "Systemprog." button on the **control device** for 3 seconds to start programming mode (see Page 19).
  3. Press any call button on the **door station** for 6 seconds to delete the existing assignments.
  4. Press all call buttons on the **door station** one after another in the sequence of the first start-up for 3 seconds to restore the assignments.
- ✓ The replacement and the old assignment of call buttons is restored with this. No further programming at the home stations is necessary.
5. Press the "Systemprog." button on the **control device** to exit the programming mode.
  6. Carry out a function test.  
If the call buttons were assigned in the wrong order, repeat the procedure and press the call buttons in the reverse order.















### Replacement of a door communication bus coupler

When replacing a door communication bus coupler, the system must be restarted, i.e. access to the home station/the floor-call button is required.

## LED indicators on BUS devices

The LEDs of the hands-free feature, Comfort with receiver, surface-mounted hands-free feature and surface-mounted gong home stations indicate the system status:

LED/button	System status
 or  flashes	Programming mode active – call-buttons and/or gong not yet assigned
 or  lights up	Programming mode active – at least one call button is already assigned to the home station or the gong
 lights up	Programming mode active – home station memory of occupied by 10 call buttons (Occupied on the surface-mounted hands-free feature home station with 15 call buttons)
 lights up long/short	Programming mode active long = automatic door opener enabled short = automatic door opener disabled
 lights up	Automatic door opener activated
 flashes 2 min	Comfort home station with receiver: signals incoming call
 lights up	Comfort home station with receiver: a call is in progress
 flashes 2 min	Hands-free feature and surface-mounted hands-free feature home station: signals incoming call
 lights up	Hands-free feature and surface-mounted hands-free feature home station: a call is in progress
 lights up	Call tone is deactivated

## Acknowledgement tones of Bus devices

---

In programming mode, the following conditions are indicated using acknowledgement tones:

Acknowledgement tone	Meaning
Short tone	<ul style="list-style-type: none"><li>• During assignment: release button</li><li>• While deleting: no meaning, continue to hold down button</li></ul>
Long tone	<ul style="list-style-type: none"><li>• During assignment: call button was assigned successfully</li><li>• While deleting: release button, assignment is deleted</li></ul>
3 short tones	<ul style="list-style-type: none"><li>• During assignment: call button was not assigned*</li><li>• Memory of door station for calling up learned-in call buttons is occupied (maximum of 20 call buttons)</li><li>• When assigning a door opener: 3 door openers were already assigned</li></ul>

a call button cannot be assigned if:

- the home station memory is already occupied by 10 (15) call buttons. In this case, the  LED of the hands-free feature, surface-mounted hands-free feature and Comfort with receiver home station lights up. A maximum of 10 call buttons can be assigned to a home station (a maximum of 15 call buttons to a surface-mounted hands-free feature home station).
- no call buttons at the door or home station were pressed beforehand.
- all previously pressed call buttons were already assigned to other home stations.

## Table for start-up documentation

---

<b>Call button</b> (Number / Name)	<b>Home station</b> (Name / Location / Floor)	<b>Taught-in</b>
Meier	2 <sup>nd</sup> floor left, living room	†

<b>Call button</b> (Number / Name)	<b>Home station</b> (Name / Location / Floor)	<b>Taught-in</b>

## Acceptance of guarantee

---

The warranty is provided in accordance with statutory requirements via the specialist trade.

Please submit or send faulty devices postage paid together with an error description to your responsible salesperson (specialist trade/installation company/electrical specialist trade).

They will forward the devices to the Gira Service Center.



Gira  
Giersiepen GmbH & Co. KG  
Elektro-Installations-  
Systeme  
Postfach 1220  
42461 Radevormwald  
Deutschland  
Tel +49 (0) 21 95 / 602 - 0  
Fax +49 (0) 21 95 / 602 - 191  
[www.gira.de](http://www.gira.de)  
[info@gira.de](mailto:info@gira.de)

# GIRA