

switching actuator 4fold 16A DRA

Bestell-Nr: 1004 00



switching actuator 8fold 16A DRA

Bestell-Nr: 1006 00

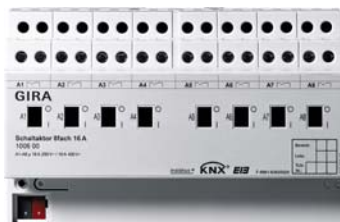

Date of issue: 08.2006

Table of Contents

| | | |
|-----------------|--|------------------|
| <u>1</u> | <u>Product definition</u> | <u>3</u> |
| 1.1 | Product catalogue | 3 |
| 1.2 | Function | 3 |
| <u>2</u> | <u>Fitting, electrical connection and operation</u> | <u>4</u> |
| 2.1 | Safety instructions | 4 |
| 2.2 | Device components | 5 |
| 2.3 | Fitting and electrical connection | 6 |
| 2.4 | Commissioning | 7 |
| 2.5 | Operation | 8 |
| <u>3</u> | <u>Technical data</u> | <u>9</u> |
| <u>4</u> | <u>Software information</u> | <u>11</u> |
| 4.1 | Software specifications | 11 |
| 4.2 | Software "switching SM, LF, TF 2088x1 / 2090x1" | 12 |
| 4.2.1 | Scope of functions | 12 |
| 4.2.2 | Software information | 13 |
| 4.2.3 | Object table | 14 |
| 4.2.4 | Functional description | 18 |
| 4.2.4.1 | Description of functions affecting several channels: | 18 |
| 4.2.4.2 | Channel-oriented functional description | 22 |
| 4.2.4.3 | Delivery state | 51 |
| 4.2.5 | Parameters | 52 |

1 Product definition

1.1 Product catalogue

Product name: switching actuator 4fold 16A DRA / switching actuator 8fold 16A DRA
Use: actuator
Design: REG (rail-mounted device)
Order no.: 4fold: 1004 00 / 8fold: 1006 00

1.2 Function

The switching actuator receives telegrams from sensors or other controls via the KNX / EIB and switches electrical consumers by means of its relay contacts which are independent of one another. Each switching output has a separate bistable switching relay so that the states of the switching contacts are safely maintained even in case of bus voltage failure.

With the slide switches on the device front panel, the relays can be switched on and off by hand parallel to the KNX / EIB even without bus voltage or in a non-programmed state. This feature permits fast checking of connected consumers for proper functioning.

The functionalities that can be programmed independently with the ETS for each output channel include among other things extensive timing functions, logic operations, scenes, disabling functions, operating hours counter, cyclical monitoring and an enlarged range of response telegrams. Centralized switching of all outputs is also available. Moreover, the preferred states of the relay contacts in case of bus voltage failure or bus voltage return and after ETS programming can be preset separately.

For project design and commissioning of this device it is recommended to use the ETS3.0d. The advantages with regard to downloading (shorter loading times) and parameter programming are available only if this new ETS patch version or later versions are used. For the ETS2 and older versions of the ETS3 a separate product database is available.

The switching actuator is supplied with power from the KNX / EIB and therefore does not need an additional external power supply. The device is designed for fitting on DIN rails in closed compact boxes or in power distributions in fixed installations in dry rooms.

2 Fitting, electrical connection and operation

2.1 Safety instructions

Electrical equipment must be installed and fitted only by qualified electricians. Observe the current accident prevention regulations.

Failure to observe any of the installation instructions may cause damage to the device and result in fire and other hazards.

Before working on the device or before replacing any connected loads, disconnect the supply voltage (by cutting out the circuit breaker) to avoid the risk of an electric shock.

The switching actuator is not suited for safe disconnection of the mains.

Do not connect mains voltage and SELV/PELV circuits to the same switching actuator.

Do not connect three-phase AC motors to the actuator.

Make sure during the installation that there is always sufficient insulation between the mains voltage and the bus. A minimum spacing of 4 mm must be ensured between bus wires and mains conductors.

Do not open the device and do not operate it outside the scope of the technical specifications.

2.2 Device components

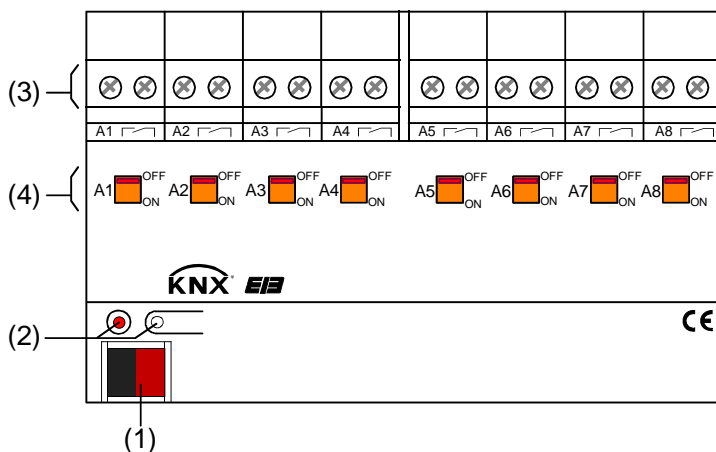
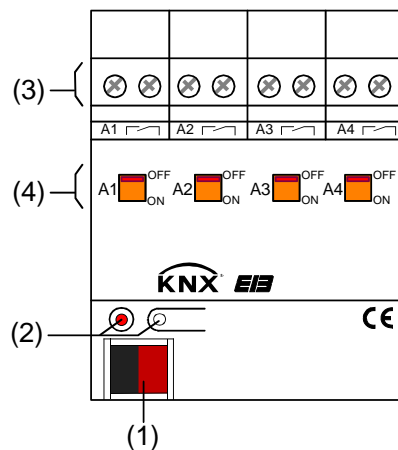

Dimensions:

width (W):
144 mm (8 MW)

height (H):
90 mm

depth (D):
70 mm

- (1): KNX/EIB bus connection
- (2): Programming button and programming LED (red). The programming LED flashes slowly when the safe-state mode is active.
- (3): Screw terminals (Ax,) for connection of different loads (potential-free)
- (4): Slide switches for relay control and for indication of the switching states
Position 'OFF': contact open
Position 'ON': contact closed

2.3 Fitting and electrical connection



DANGER!

Electric shock in case of accidental contact with live parts. Electric shocks can be fatal. Before working on the device, cut out the mains supply and cover up live parts in the surroundings.

Fitting

- Fit the device by snapping it onto a mounting rail in acc. with DIN EN 60715. The screw terminals for connection of the load should be at the top.
- ⓘ A KNX / EIB data rail is not required.
- ⓘ Observe the temperature range (-5 °C ...+45 °C) and ensure sufficient cooling.

Connection

- Connect the loads and the bus line as shown in fig. 1 (connection example).

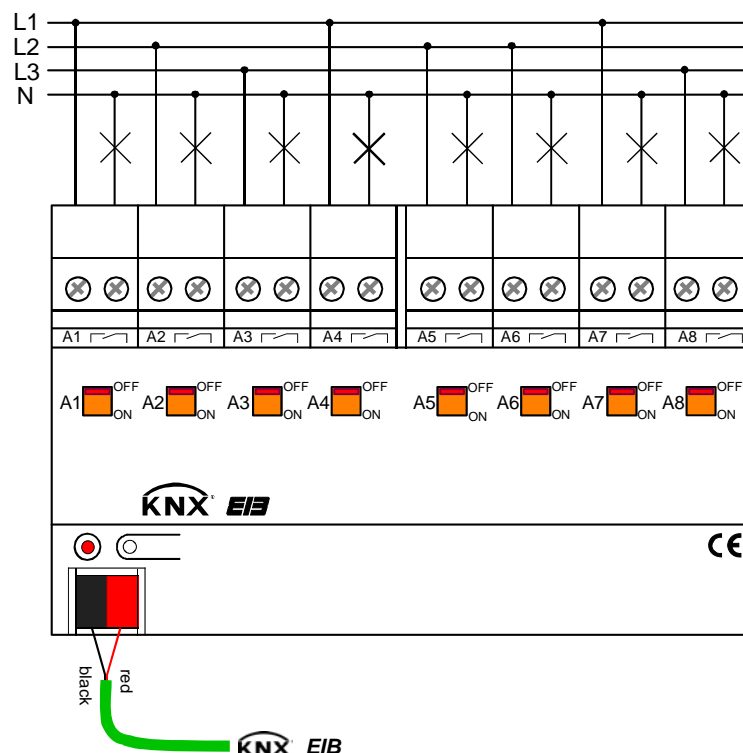

Fig. 1: Electrical connection

- ⓘ The relay output contacts of the switching actuator react at brief intervals when actuated or with a slight time delay when actuated by a central control telegram.
- ⓘ The device accepts different phase conductors (L1, L2, L3) at the outputs.
- ⓘ Do not connect three-phase AC motors to the actuator.

Installing / removing the protective cap

To protect the bus lines against hazardous voltages, especially in the area of the connecting terminals, a protective cap can be installed.

The bus must be connected with the bus line led out at the rear (bus terminal plugged into device).

- To install the cap: Slide the cap over the bus connecting terminal until it snaps in place (cf. Fig. 2-A).
- To remove the cap: Remove the cap by pressing the sides slightly and by pulling it out to the front (cf. Fig. 2-B).

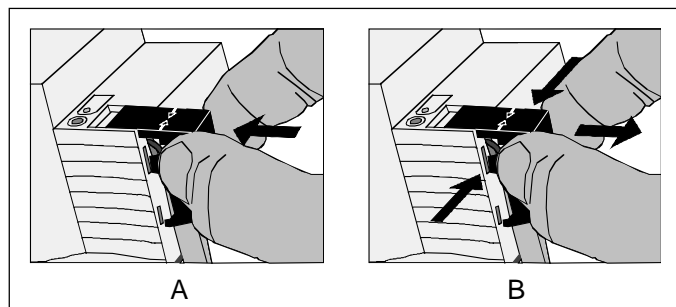

Fig. 2: Installing / removing the protective cap

2.4 Commissioning

After installation of the actuator and connection of the bus line and of all electrical loads, the device can be put into operation. The following procedure is generally recommended...



DANGER!

Electric shock in case of accidental contact with live parts. Electric shocks can be fatal. Before working on the device, cut out the mains supply and cover up live parts in the surroundings.

Putting the device into operation

All loads must have been completely installed and connected.

- Switch on the bus voltage Check: the red programming LED must light up when the programming button is being depressed.
 - Download the physical address and the application data with the ETS.
 - Switch on the mains voltage supply to the outputs.
 - The device is now ready for operation.
- [i] The outputs of the actuator can be switched manually even without bus voltage and in the unprogrammed state of the actuator. Due to this feature, the loads connected to the individual outputs can be checked for proper functioning already during site operation.

2.5 Operation

The switching position of the relays is indicated by slide switches on the front panel of the device (cf. Fig. 3). The switches are also provided for manual operation and can be actuated with a suitable tool (e.g. screwdriver).

Manual operation of an output

- Slide the switch into the 'OFF' position
The relay contact is open.
- Slide the switch into the 'ON' position
The relay contact is closed.



Fig. 3: Slide switch for each output with indication of switching position

- i** The position of the slide switch shows directly the switching state of the relay independently of the mode of operation of the output (programming as make or break contact).
- i** Manual switching of the relays is independent of the bus. In case of manual switching there will be no feedback via the bus.
- i** Manual operation of the slide switches does not inhibit operation via the bus. An output last operated by hand can at any time be controlled via the bus.
- i** An output disabled via the bus can nevertheless be operated by hand!

3 Technical data

| | |
|----------------------------------|---|
| Type of protection | IP 20 |
| Safety class: | III |
| Mark of approval: | KNX / EIB / VDE |
| Ambient temperature: | -5 °C ...+45 °C |
| Storage / transport temperature: | -25 °C...+70 °C (Storage above + 45 °C reduces the lifetime) |
| Mounting position: | any position (preferred: output terminals at the top) |
| Minimum distances: | none |
| Type of fastening: | Snap-fastening on DIN rail in closed cabinets (e.g. small distributions, etc.) / KNX / EIB data rail not required. |
| | |
| KNX / EIB supply | |
| Voltage: | 21...32 V DC SELV |
| Power consumption: | typically 150 mW |
| Connection: | with screw terminals: 0,5...4 mm ² solid and stranded wire without ferrule 0,5...2,5mm ² stranded wire with ferrule Max. tightening torque: 0.8 Nm |
| External supply | --- |
| Total power loss: | 4-channel switching actuator: max. 4 W 8-channel switching actuator: max. 8 W |
| | |
| Response to bus voltage failure: | depending on parameterization cf. chapter 4. "Software description") |
| Response to bus voltage return: | depending on parameterization cf. chapter 4. "Software description") |
| | |
| Output: | |
| Number: | 8 |
| Type of contact: | potential-free μ -contact, bistable |
| Switching voltage: | 230 V AC; 50 / 60 Hz 400 V AC; 50 / 60 Hz 24 V DC |
| Switching capacity 230 V AC | 16 A / AC 1 10 A / AC 3 |
| Switching capacity 400 V AC | 10 A / AC 1 6 A / AC 3 |
| Switching capacity DC | 16 A / 24 V (resistive load) |
| max. Inrush current: | 400 A, 150 μ s 200 A, 600 μ s |
| min. switching current: | 100 mA (at 24 V) |

Technical data (continued)

Output:

| | |
|-------------|--|
| Number: | 4-channel switching actuator: 4 8-channel switching actuator: 8 |
| Connection: | with screw terminals: 0.5...4 mm ² solid and stranded wire without ferrule 0.5...2.5 mm ² stranded wire with ferrule Max. tightening torque: 0.8 Nm |

Switching capacity:

| | |
|------------------|------------------|
| Resistive load | 3600 W |
| Capacitive load: | 10 A max. 140 µF |

Lamp loads:

| | |
|----------------------------|---------|
| Incandescent lamps: | 2500 W |
| HV halogen: | 2500 W |
| LV halogen: | |
| conventional transformers: | 1200 VA |
| Tronic transformers: | 1500 W |

Fluorescent lamps T5 / T8

| | |
|-----------------------|----------------|
| non-compensated | 2500 W |
| parallel compensated: | 1300 W, 140 µF |
| Lead-lag circuit: | 2300 W, 140 µF |

Compact fluorescent lamps:

| | |
|-----------------------|----------------|
| non-compensated: | 2500 W |
| parallel compensated: | 1300 W, 140 µF |

Mercury vapour lamps:

| | |
|-----------------------|----------------|
| non-compensated: | 2000 W |
| parallel compensated: | 2000 W, 140 µF |

ELECTRONIC BALLASTS

The number of electronic ballasts that can be connected to the device depends on type and make of the ballast and additionally also on the condition of the low-voltage mains supply network. For this reason, different electronic ballasts are listed below as an example (manufacturer: Osram).

max. number per output:

T8 lamps:

| | |
|------------------------|----|
| QTP 3 x 18 W, 4 x 18 W | 17 |
| QTP 2 x 36 W | 17 |
| QTP 1 x 58 W | 17 |
| QTP 2 x 58 W | 11 |

T5 lamps:

| | |
|----------------|----|
| QT-FH 1 x 28 W | 17 |
| QT-FH 2 x 28 W | 17 |
| QT-FQ 2 x 54 W | 11 |
| QT-FQ 1 x 80 W | 11 |

4 Software information

4.1 Software specifications

ETS search paths: - output / binary output, 4fold / switching actuator 4fold 16A DRA
 - output / binary output, 8fold / switching actuator 8fold 16A DRA

BAU used: ASIC 1066 + μ C

KNX/EIB type class: 3b - Dev. with cert. PhL + stack

Configuration: S-mode standard

PEI type: "00"_{Hex} / "0"_{Dec}

PEI connector: no connector

Applications for 4-channel switching actuator REG

| No. | Summarized description: | Name | Version: | Executable from mask version: |
|-----|--|--------------------------------|--|-------------------------------|
| 1 | Multi-function 4-channel switching with timing functions, logic operations, scenes, disabling functions, operating hours counter, cyclical monitoring and an enlarged set of response telegrams. Centralized switching of all outputs is also available. Moreover, the preferred states of the relays in case of bus voltage failure or bus voltage return and after ETS programming can be preset separately. | switching SM, LF, TF 209001 | 0.1 for ETS 2 and ETS 3a...c | 705 |
| | | switching SM, LF, TF 209011 | 1.1 for ETS3 from version d onwards | |

Applications for 8-channel switching actuator REG

| No. | Summarized description: | Name | Version: | Executable from mask version: |
|-----|--|--------------------------------|--|-------------------------------|
| 1 | Multi-function 8-channel switching with timing functions, logic operations, scenes, disabling functions, operating hours counter, cyclical monitoring and an enlarged set of response telegrams. Centralized switching of all outputs is also available. Moreover, the preferred states of the relay contacts in case of bus voltage failure or bus voltage return and after ETS programming can be preset separately. | switching SM, LF, TF 208801 | 0.1 for ETS 2 and ETS 3a...c | 705 |
| | | switching SM, LF, TF 208811 | 1.1 for ETS3 from version d onwards | |

4.2 Software "switching SM, LF, TF 2088x1 / 2090x1"

4.2.1 Scope of functions

- Each output offers the full scope of functions without any restrictions. All channel-oriented functions can be parameterized separately for each output. This feature permits independent and multi-functional control of the switching outputs.
- Bus-independent manual switching of relays / switching position indication.
- Operation as break or make contacts.
- Central switching function with centralized feedback.
- Switching feedback mode (only with bus operation): active (after changes or cyclical transmission to the bus) or passive (object readout function) feedback function.
- Logic function individual for each output.
- Disabling function parameterizable for each channel. Forced-control position function separately for each output as an alternative.
- Timing functions (ON-delay, OFF-delay, staircase lighting timer, also with early-warning function)
- Incorporation into light-scenes: up to 8 internal scenes parameterizable per output.
- Operating hours counter can be activated independently for each output.
- Input monitoring for cyclical updates with safety circuit.
- Behaviour in case of bus voltage failure and bus voltage return as well as after ETS programming presettable for each output.

4.2.2 Software information

ETS project design and commissioning

For project design and commissioning of this device it is recommended to use the ETS3.0d. Advantages with regard to downloading (significantly shorter loading times) and parameter programming can be expected only if this ETS patch version or later versions are used. The advantages consist in using the new mask version 7.5 and the parameter presentation of the ETS3.

The product database required for the ETS3.0d is offered in the *.VD4 format. The corresponding application program is version number "1.1". For the ETS2 and older versions of the ETS3 a separate product database in the *.VD2 format is available. The application program for this ETS version is number "0.1".

As far as the programming scope of functions described in this documentation is concerned, there is no difference between the two application programs.

When older ETS versions are updated to the level of version ETS3.0d or to that of later versions, an additional tool in the form of an ETS add-in is available. This tool is capable of converting older product databases of application version "0.1", for instance from existing ETS2 projects, into the new application format (version "1.1"). This feature permits making use of the advantages of the ETS3.0d application in an easy way and without any changes. The ETS3 add-in can be obtained separately from the manufacturer and is free of charge.

Safe-state mode

If the device - for instance as a result of errors in the project design or during commissioning - does not work properly, the execution of the loaded application program can be halted by activating the safe-state mode. In the safe-state mode, the outputs cannot be controlled via the bus. The actuator remains passive since the application program is not being executed (state-of-execution: terminated). Only the system software is still functional so that the ETS diagnosis functions and also the programming of the device continue to be visible.

Activation of the safe-state mode

The bus voltage is not yet connected.

- Press the programming button and keep it pressed.
- Switch on the bus or mains voltage. Release the programming button only after the programming LED starts flashing slowly.

The safe-state mode is activated. With a new brief press on the programming button, the programming mode can be switched on and off as usual also in the safe-state mode. The programming LED will nevertheless continue to flash independently of the programming mode as long as the safe-state mode is active.

 The safe-state mode can be terminated by switching off the bus voltage or by programming with the ETS.

4.2.3 Object table

| | |
|----------------------------------|--|
| Number of communication objects: | 4-channel: 50 (max. object number 100 – gaps in between) 8-channel: 98 (max. object number 204 – gaps in between) |
| Number of addresses (max): | 254 |
| Number of assignments (max): | 255 |
| Dynamic table management | no |
| Maximum table length | 255 |

Objects affecting several channels:

Function: Central function

| Object | Function | Name | Type | DP type | Flag |
|---|----------------------------|-----------------------|-------|---------|---------------------------|
|  8 | Central switching function | All switching outputs | 1 bit | 1.001 | C, W, -, (R) ¹ |

Description: 1-bit object for central switching of switching outputs assigned. The polarity can be parameterized.

Function: Centralized feedback

| Object | Function | Name | Type | DP type | Flag |
|---|----------------------|-----------------------|---------|---------|-------------------------|
|  9 | Centralized feedback | All switching outputs | 4 bytes | 27.001 | C, -, T, R ² |

Description: 4-byte object for centralized feedback of all of the actuators switching states.

¹ Every communication object can be read out. For readout, the R-flag must be set.

² Depending on parameterization, feedback objects are either actively transmitting (C-flag set) or passively readable (R-flag set).

Channel-oriented objects:

Function: Output switching

| Object | Function | Name | Type | DP type | Flag |
|---|-----------|---------------------------|-------|---------|---------------------------|
|  10, 36, 62, 88, 114, 140, 166, 192 ³ | Switching | Output 1 – 8 ³ | 1 bit | 1.001 | C, W, -, (R) ¹ |

Description: 1-bit object for controlling one output ("1" = on / "0" = off; observe the parameterized operating mode!).

Function: Forced-control position

| Object | Function | Name | Type | DP type | Flag |
|---|-------------------------|---------------------------|-------|---------|---------------------------|
|  11, 37, 63, 89, 115, 141, 167, 193 ³ | Forced-control position | Output 1 – 8 ³ | 2 bit | 2.001 | C, W, -, (R) ¹ |

Description: 2-bit object for forced control of an output. The object state after bus voltage return can be predefined by parameters.

Function: Disabling function

| Object | Function | Name | Type | DP type | Flag |
|---|-----------|---------------------------|-------|---------|--------------------------|
|  12, 38, 64, 90, 116, 142, 168, 194 ³ | Disabling | Output 1 – 8 ³ | 1 bit | 1.003 | C,W, -, (R) ¹ |

Description: 1-bit object for disabling of an output (polarity parameterizable).

Function: Logic operation

| Object | Function | Name | Type | DP type | Flag |
|---|-----------------|---------------------------|-------|---------|---------------------------|
|  13, 39, 65, 91, 117, 143, 169, 195 ³ | Logic operation | Output 1 – 8 ³ | 1 bit | 1.002 | C, W, -, (R) ¹ |

Description: 1-bit object for the input of the logic operation of an output. The object value after bus voltage return or after programming with the ETS can be predefined with parameters.

³ The number of outputs of the communication objects depends on the programmed device (switching actuator 4-channel = 4 outputs or switching actuator 8-channel = 8 outputs).

¹ Every communication object can be read out. For readout, the R-flag must be set.

Function: Staircase function

| Object | Function | Name | Type | DP type | Flag |
|---|-------------------------------|---------------------------|-------|---------|--------------------------|
|  14, 40, 66, 92, 118, 144, 170, 196 ³ | Staircase function start/stop | Output 1 – 8 ³ | 1 Bit | 1.010 | C,W, -, (R) ¹ |

Description: 1-bit object for activation or deactivation of the time delay of the staircase function of an output ("1" = on / "0" = off).

Function: Staircase function

| Object | Function | Name | Type | DP type | Flag |
|---|---------------------------|---------------------------|--------|---------|--------------------------|
|  15, 41, 67, 93, 119, 145, 171, 197 ³ | Staircase function factor | Output 1 – 8 ³ | 1 byte | 5.010 | C,W, -, (R) ¹ |

Description: 1-byte object for setting the time factor for the lighting time of the staircase timer function (value range: 0 ... 255).

Function: Scene function

| Object | Function | Name | Type | DP type | Flag |
|--|-----------------|---------------------------|--------|---------|--------------------------|
|  16, 42, 68, 94, 120, 146, 172, 198 ³ | Scene extension | Output 1 – 8 ³ | 1 byte | 18.001 | C,W, -, (R) ¹ |

Description: 1-byte object for recalling scenes or for storing new scene values.

Function: Switching status feedback

| Object | Function | Name | Type | DP type | Flag |
|---|--------------------|---------------------------|-------|---------|-------------------------|
|  18, 44, 70, 96, 122, 148, 174, 200 ³ | Switching feedback | Output 1 – 8 ³ | 1 bit | 1.001 | C, -, T, R ² |

Description: 1-bit object for feedback signalling of the switching state of an output ("1" = on / "0" = off; observe the parameterized mode of operation!)

³ The number of outputs of the communication objects depends on the programmed device (switching actuator 4-channel = 4 outputs or switching actuator 8-channel = 8 outputs).

¹ Each communication object can be read out. For readout, the R-flag must be set.

² Depending on parameterization, feedback objects are either actively transmitting (C-flag set) or passively readable (R-flag set).

Function: Operating hours counter

| Object | Function | Name | Type | DP type | Flag |
|--|---|---------------------------|---------|---------|---------------------------|
| <input type="checkbox"/> 19, 45, 71, 97, 123, 149, 175, 201 ³ | Limit value / start value operating hours counter ⁴ | Output 1 – 8 ³ | 2 bytes | 7.007 | C, W, -, (R) ¹ |

Description: 2-byte object for external preset of a limit value / start value for the operating hours counter of an output (value range: 0 ... 65535).

Function: Operating hours counter

| Object | Function | Name | Type | DP type | Flag |
|--|--------------------------------------|---------------------------|-------|---------|---------------------------|
| <input type="checkbox"/> 20, 46, 72, 98, 124, 150, 176, 202 ³ | New start operating hours counter | Output 1 – 8 ³ | 1 bit | 1.015 | C, W, -, (R) ¹ |

Description: 1-bit object for resetting the operating hours counter of an output ("1" = reset, "0" = no reaction).

Function: Operating hours counter

| Object | Function | Name | Type | DP type | Flag |
|--|----------------------------------|---------------------------|---------|---------|---------------------------|
| <input type="checkbox"/> 21, 47, 73, 99, 125, 151, 177, 203 ³ | Value operating hours counter | Output 1 – 8 ³ | 2 bytes | 7.007 | C, -, T, (R) ¹ |

Description: 2-byte object for transmission or readout of the current count of the operating hours counter. The value of the communication object is not lost after a bus voltage failure and is actively transmitted the bus after bus voltage return or after programming with the ETS. As delivered, this value is "0".

Function: Operating hours counter

| Object | Function | Name | Type | DP type | Flag |
|---|-----------------------------------|---------------------------|-------|---------|---------------------------|
| <input type="checkbox"/> 22, 48, 74, 100, 126, 152, 178, 204 ³ | Runout operating hours counter | Output 1 – 8 ³ | 1 bit | 1.002 | C, -, T, (R) ¹ |

Description: 1-bit object for signalling that the operating hours counter has run out (up-counter = limit value reached / down-counter = value "0" reached). In case of signalling, the object value is transmitted to the bus ("1" = message active / "0" = message inactive). The value of the communication object is not lost after a bus voltage failure and is actively transmitted the bus after bus voltage return or after programming with the ETS when the message is active. If not, only the object will be initialized.

⁴ Limit value object or start value object depending on type of counter programmed as operating hours counter.

³ The number of outputs of the communication objects depends on the programmed device (switching actuator 4-channel = 4 outputs or switching actuator 8-channel = 8 outputs).

¹ Each communication object can be read out. For readout, the R-flag must be set.

4.2.4 Functional description

4.2.4.1 Description of functions affecting several channels:

Delay after bus voltage return

To reduce telegram traffic on the bus line after bus voltage activation (bus reset), after connection of the device to the bus line or after programming with the ETS, it is possible to delay all actively transmitted feedback telegrams of the actuator. For this purpose, a delay affecting several channels can be specified (parameter "Delay after bus voltage return" on parameter page "General". Feedback telegrams for bus initialization will therefore be transmitted to the bus only after the parameterized time has elapsed.

Which of the feedback telegrams is actually delayed and which is not can be specified for each output channel and for each feedback function separately.

- ❏ The delay has no effect on the behaviour of the outputs. Only the feedback telegrams are delayed. The outputs can also be activated during the delay after bus voltage return.
- ❏ Moreover, all actively transmitting objects of the operating hours counter are to be handled as feedback objects as well. In this case, however, all feedback telegrams are always transmitted with a delay depending on the parameter selected under "Delay after bus voltage return".
- ❏ A setting of "0" for the delay after bus voltage return deactivates the delaying function altogether. In this case, all feedback telegrams, if actively transmitted, will be transmitted to the bus without any delay.

Central function

The actuator offers the possibility of linking selected individual or all output channels with a 1-bit central communication object. The behaviour in case of activating an output via the central function is comparable to a central group address linked with all "Switching" objects.

The outputs assigned to the central function are activated in accordance with the central object value received. The polarity of the central telegram can, if necessary, be inverted by means of a parameter.

The behaviour of the channels is identical with 'normal' activation via the "Switching" objects (same priority – last switching command is executed – cf. Fig. 4). In this way, all 'secondary' functions such as timing or supplementary functions or logic operations are included as well. The parameterized relay operation is also evaluated for each output separately.

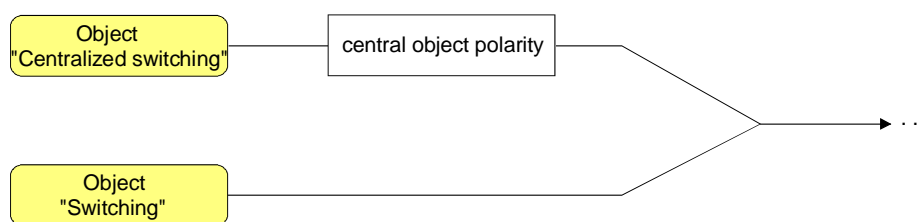

Fig.4: Functional diagram "Centralized switching"

Enabling the central function

- Enable the central function on parameter page "General" by setting the "Central function?" parameter to "Yes".

When the function is activated, the "Centralized switching" communication object is visible.

Assigning outputs to the central function

Each output can be assigned independently to the central function.

The central function must have been enabled on parameter page "General". The assignment has otherwise no effect on the switching output.

- Set the "Assignment to central function" parameter on the "Ax-General" page (x = number of output) to "Yes".

The corresponding output is now assigned to the central function. It can be switched on or off from a central control station.

- ❗ The switching state set by the central function is tracked in the feedback objects and also transmitted to the bus, if they are actively transmitting. The switching state set by a central function is not tracked in the "Switching" objects.
- ❗ After a bus voltage return or after programming with the ETS, the central function is always inactive (object value "0").

Centralized feedback

After central commands or after bus voltage return, a bus line is generally heavily loaded by data traffic as many bus devices are transmitting the state of their communication objects by means of feedback telegrams. This effect is particularly remarkable when visualizations are used. To keep the telegram load low during a 'bus initialization', the centralized feedback function of the actuator can be employed. The centralized feedback function groups the switching states of all outputs together in only one telegram. The 32-bit wide communication object "Centralized feedback" contains the feedback information of the individual outputs in a bit-oriented format and is organized as shown Fig. 5.

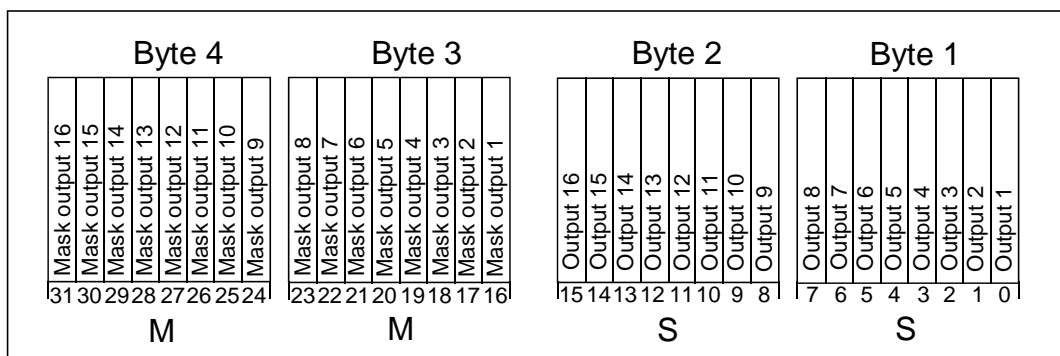

Fig. 5: Structure of the centralized feedback object

The object permits representing up to 16 outputs and thus up to 16 different switching states in a logical format, with each output having one bit representing the switching state ("S" bit) and another one defining the masking ("M" bit). The "S" bits correspond to the logical non-inverted switching states of the outputs and are either "1" (on) or "0" (off). The "M" bits are "1", if there is such an output on the actuator. Likewise, the "M" bits are "0", if there is no corresponding output on the actuator. In the latter case, the pertaining "S" bits are permanently "0" because there is no switching state.

Object value format for 4-channel switching actuator: "00 0F 00 0x", x = switching states,
Object value format for 8-channel switching actuator: "00 FF 00 xx", xx = switching states.

The datapoint type of the centralized feedback is KNX-standardized (DPT 27.001). It could be used in suitable visualization applications, for instance in public buildings like schools or hospitals, where the switching states of all actuators are displayed centrally and not separately at the local control units. In such applications, the centralized feedback can replace the 1-bit single feedback and thus reduce the bus load significantly.

Activating the centralized feedback function

The centralized feedback can be used as an active message object or as a passive status object. As an active message object, the centralized feedback information is transmitted to the bus whenever a switching state changes. On the other hand, no telegram will be transmitted when it is used as a passive status object. In this case, the object value must be read out. The ETS automatically sets the object communication flags required for proper functioning.

- The parameter "Make use of centralized feedback ?" of the required function must be set to "Yes, active message object" or "Yes, passive status object".

The 4-byte communication object "Centralized feedback" is enabled. The object can be used when it has been linked with a group address.

Activating centralized feedback on bus voltage return or after ETS programming

The centralized feedback state is transmitted to the bus after bus voltage return or ETS programming if used as active message object. In this case, the feedback can be delayed with the delay being set globally for all outputs together (cf. "Delay after bus voltage return").

- Set the parameter "Time delay for feedback telegram after bus voltage return" of the centralized feedback to "Yes".

The centralized feedback is transmitted with a delay after bus voltage return or ETS programming. No feedback telegram is transmitted during a running delay, even if a switching state changes during this delay.

- Set the parameter "Time delay for feedback telegram after bus voltage return" of the centralized feedback to "No".

The feedback telegram is transmitted immediately after bus voltage return or ETS programming.

Activating cyclical transmission for centralized feedback telegrams

By means of the actively transmitting signalling object, the centralized feedback telegram can – besides being sent in case of state changes – also be transmitted cyclically.

- Set the parameter "Cyclical transmission of centralized feedback telegram ?" on parameter page "General" to "Yes".

Cyclical transmission is now activated.

- Set the parameter "Cyclical transmission of centralized feedback telegram ?" on parameter page "General" to "No".

Cyclical transmission is deactivated so that the centralized feedback is transmitted to the bus only when one of the switching states changes.

- ❗ The cycle time is defined centrally for all cyclical feedback telegrams on the parameter page "Time settings".
- ❗ No centralized feedback telegram is transmitted during an active delay after bus voltage return, even if a switching state changes during the delay.
- ❗ A blinking 'output' (cf. "disabling function") will always be reported back as "switched on".
- ❗ Changes of the switching state made manually are not detected.

4.2.4.2 Channel-oriented functional description

Mode of operation

The relays of a switching output can be parameterized as make or break contacts. This feature offers the possibility of inversion the switching states. The preset mode of operation has consequences for the switching state feedback function.

Setting the mode of operation

The parameter "Mode of operation" exists separately for each output channel on the parameter page "Ax - General" (x = number of output).

- Program the relay contact as "make contact".
Switching state = off ("0") → relay contact open,
Switching state = on ("1") → relay contact closed.
- Program the relay contact as "break contact".
Switching state = off ("0") → relay contact closed,
Switching state = on ("1") → relay contact open.

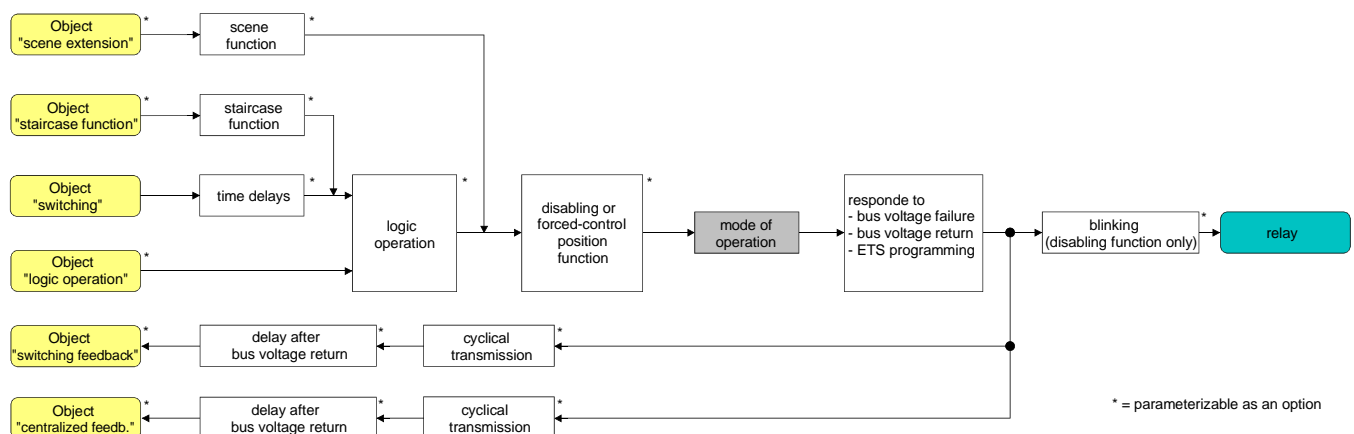

Fig. 6: Functional diagram "Mode of operation"

- ❗ The logic switching state ("on - 1" or "off – 0") is set by the communication object "Switching" and influenced by the functions that can be optionally activated (e.g. timing/staircase functions, logic operations, disabling/forced-control position functions, scenes – cf. Fig. 6).
- ❗ A switching state set after bus voltage return or after ETS programming will be tracked in the feedback object depending on the "Mode of operation" parameter.

Reaction after bus voltage failure / return or after ETS programming

The preferred relay contact positions after bus voltage return or after ETS programming can be preset separately for each output. Since the actuator is equipped with bistable relays, the relay switching state at bus voltage failure can be defined as well.

Presetting the Behaviour after ETS programming

The parameter "Behaviour after ETS programming" can be preset separately for each output channel on the parameter page "Ax - General" (x = number of output). This parameter can be used to parameterize the output relay behaviour independent of the behaviour after bus voltage return.

- Set the parameter to "no reaction".
After ETS programming, the relay of the output shows no response and remains in the switching state last selected. The internal logic switching state is not lost either by an ETS programming cycle.
 - Set the parameter to "close contact".
The relay contact is closed after an ETS programming cycle.
 - Set the parameter to "open contact".
The relay contact is opened after an ETS programming cycle.
- i** The parameterized behaviour will be executed after every application or parameter download by the ETS. Downloading only the physical address or programming the group addresses only partially has the effect that this parameter will be disregarded and the parameterized "Behaviour after bus voltage return" be adopted.
- i** A switching state set after an ETS programming cycle will be tracked in the feedback object depending on the "Mode of operation" parameter.

Presetting the behaviour in case of bus voltage failure

The parameter "Behaviour in case of bus voltage failure" can be preset separately for each output channel under "Ax - General" (X = number of output).

- Set the parameter to "no reaction".
In case of bus voltage failure, the relay of the output shows no reaction and remains in the switching state last selected.
- Set the parameter to "close contact".
The relay contact is closed on bus voltage failure.
- Set the parameter to "open contact".
The relay contact is opened on bus voltage failure.

Presetting the reaction after bus voltage return

The parameter "Behaviour after bus voltage return" can be preset separately for each output channel on parameter page "Ax - General" (x = number of output).

- Set the parameter to "close contact".
The relay contact is closed after bus voltage return.
 - Set the parameter to "open contact".
The relay contact is opened after bus voltage return.
 - Set the parameter to "State as before bus voltage failure".
After bus voltage return, the switching state last selected before bus voltage failure and internally stored on bus voltage failure will be tracked.
 - Set the parameter to "no reaction".
After bus voltage return, the relay of the output shows no reaction and remains in the switching state last selected.
 - Set the parameter to "Activate staircase function (if parameterized)".
The staircase function is activated after bus voltage return independent of the "Switching" object. For this setting it is indispensable that the staircase function has been programmed and enabled beforehand. When the staircase function has not been enabled, this setting will produce no reaction after bus voltage return.
- ❗ "No reaction" setting: On return of bus voltage, the switching state will be internally set back to "switched off - 0" independent of the position of the relay contacts. The feedbacks will also be initialized this way, if applicable even in inverted form.
In this case, the switching status returned corresponds to the 'true' relay status only after the outputs have been activated at least once via the bus.
- ❗ The actuator takes its power supply completely from the bus and switches the output relays only after a sufficient amount of energy has been stored. For this reason, there may be a brief delay after a bus voltage return (5 s max.) before the device adopts the parameterized behaviour.
- ❗ The device adopts the parameterized behaviour only if the last ETS programming of the application or of the parameters occurred at least ca. 20 s ago. Otherwise ($T_{ETS} < 20$ s), the "Behaviour after ETS programming" will be adopted even after a return of the bus voltage.
- ❗ The parameterized behaviour will only be adopted, if no forced control is activated after a bus voltage return.
- ❗ A switching state set after a bus voltage return will be tracked in the feedback object depending on the "Mode of operation" parameter.

Switching status feedback

The actuator can return the switching status set at its output ("on" or "off") to the bus (cf. Fig. 7). The returned feedback value can optionally be inverted.

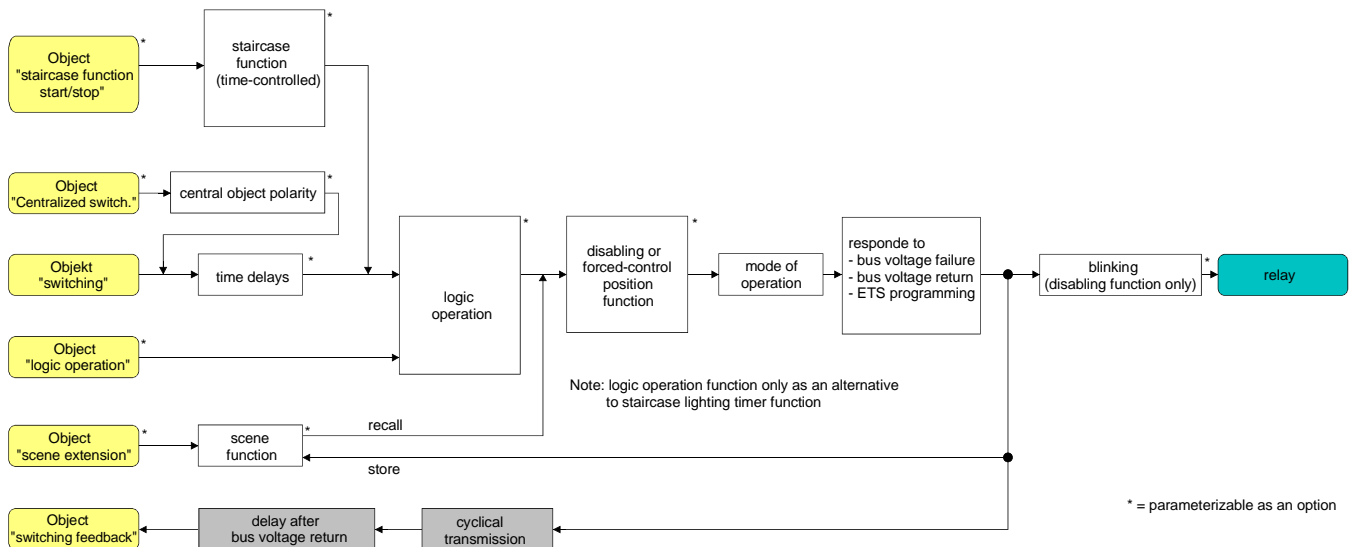

Fig. 7: Functional feedback diagram

Activating the switching status feedback function

The switching status feedback can be used as an active message object or as a passive status object. As an active message object, the switching status feedback information is transmitted to the bus whenever a switching state changes. As a passive status object, there is no telegram transmission after a change. In this case, the object value must be read out. The ETS automatically sets the object communication flags required for proper functioning.

The parameter "Feedback telegram?" can be preset separately for each output channel on the parameter page "Ax - General" (x = number of output).

- Set the parameter to "no inversion, active message object" or to "inversion, active message object".
The feedback object is enabled. Depending on the setting, the switching status is transmitted in non-inverted or in inverted form as soon as a change of state occurs or after the device has been programmed with the ETS. The transmission of telegrams takes place even after return of the bus voltage.
 - Set the parameter to "no inversion, passive status object" or to "inversion, passive status object".
The feedback object is enabled. Depending on the setting, the switching status will be transmitted back in inverted or non-inverted form only if the feedback object is read by the bus. No automatic telegram transmission takes place after bus voltage return or after programming with the ETS.
- i** In case of actively transmitting objects, all status updates from "ON" to "ON" or from "OFF" to "OFF" via the object "Switching" or the object "Central switching" always cause a feedback telegram to be transmitted. If a delay is preset and if the switching state is changed via the object "Switching", the delay period must have elapsed before the feedback will be updated.

- ❗ A 'blinking' output (cf. "Disabling function") will always be reported back as "switched on".
- ❗ Switching state changes by manual operation are not detected.

Activating switching status feedback on return of bus voltage or after programming with the ETS

If used as active message object, the switching status feedback information is transmitted to the bus after bus voltage return or after programming with the ETS. In these cases, the feedback telegram can be time-delayed with the delay being preset globally for all outputs together (cf. "Delay after bus voltage return").

- Set the parameter "Time delay for feedback telegram delay after bus voltage return" on parameter page "Ax - General" (x = number of output) to "Yes".

The switching status telegram will be transmitted with a delay after bus voltage return or after programming with the ETS. No feedback telegram is transmitted during a running delay, even if a switching state changes during this delay.

- Set the parameter "Time delay for feedback telegram delay after bus voltage return" on parameter page "Ax - General" (x = number of output) to "No".

The switching status telegram will be transmitted immediately after bus voltage return or after programming with the ETS.

- ❗ In case of a feedback telegram after bus voltage return or after programming with the ETS, the parameterized mode of operation will be evaluated. Examples for a non-inverted switching status feedback telegram:

Mode of operation make contact: contact closed = feedback "on",
Mode of operation make contact: contact opened = feedback "off",
Mode of operation break contact: contact closed = feedback "off",
Mode of operation break contact: contact opened = feedback "on".

Presetting the cyclical transmission function for the switching status feedback telegram

In addition to being transmitted in case of a state change, the switching status feedback telegram can also be transmitted cyclically via the active message object.

- Set the parameter "Cyclical transmission of feedback telegram?" on parameter page "Ax - General" (x = number of output) to "Yes".

Cyclical transmission is now activated.

- Set the parameter "Cyclical transmission of feedback telegram?" on parameter page "Ax - General" (x = number of output) to "No".

Cyclical transmission is deactivated which means that a feedback telegram is transmitted to the bus only if one of the switching states changes.

- ❗ The cycle time is defined centrally for all cyclical feedback telegrams on the parameter page "Time settings"
- ❗ During an active delay after bus voltage return no feedback telegram will be transmitted even if a switching state changes.

Cyclical monitoring

The actuator offers the possibility of monitoring specific outputs or all outputs for the arrival of switching telegrams. This feature can be used to monitor such objects that have to be updated cyclically by the bus, for instance, by means of actuating variable telegrams from room temperature controllers. The polarity of the telegram update ("0" or "1") is of no importance in this case.

If the monitored objects are not updated within a fixed parameterized monitoring period, the outputs concerned will adopt their predefined preferred state. This does not mean, however, that the outputs are disabled, but rather that they will be set to the new switching state after reception of another switching telegram.

The monitoring time is preset globally for all outputs together with the "Time for cyclical monitoring" parameter on the "Time settings" parameter page. Each output has its own time control so that the parameterized monitoring time will be evaluated independent of the channel.

The time is restarted for an output (cf. Fig. 8) after each reception of a switching telegram via the objects "Switching" or "Central switching" (if a central function has been activated for the output concerned). The monitoring time is restarted automatically also after bus voltage return or after programming with the ETS.

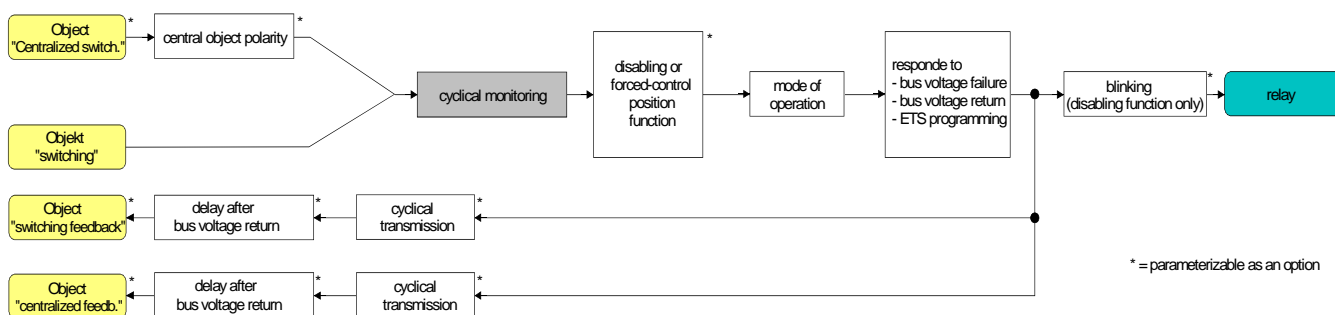

Fig. 8: Functional diagram of cyclical monitoring function

Activating the cyclical monitoring function

The cyclical monitoring function can be activated separately for each output with the parameter "Assignment to cyclical monitoring ?" on parameter page "Ax – Enabled functions" (x = number of output). When the monitoring time elapses without receiving a telegram update while the function is active, the actuator sets the output to the preferred state when the time ends.

- Set the parameter to "Yes, "ON" when time has elapsed".
The cyclical monitoring function is now activated. The output will be switched on at the end of the time.

- Set the parameter to "Yes, "OFF" when time has elapsed".
The cyclical monitoring function is now activated. The output will be switched off at the end of the time.

- ⓘ When the cyclical monitoring function is active, the following functions cannot be parameterized: time delays, staircase function, logical operation and scene.
- ⓘ If an output is already in its preferred state when the monitoring time elapses, there will be no reaction and no transmission of a feedback telegram.
- ⓘ The disabling or forced-control position function has a higher priority than the cyclical monitoring function.

Time delays

Up to two time functions can be preset independently for each output. The time functions act only on the communication objects "Switching" or "Central switching" (if a central has been activated for the output in question) and delay the received object value as a function of telegram polarity (cf. Fig. 9).

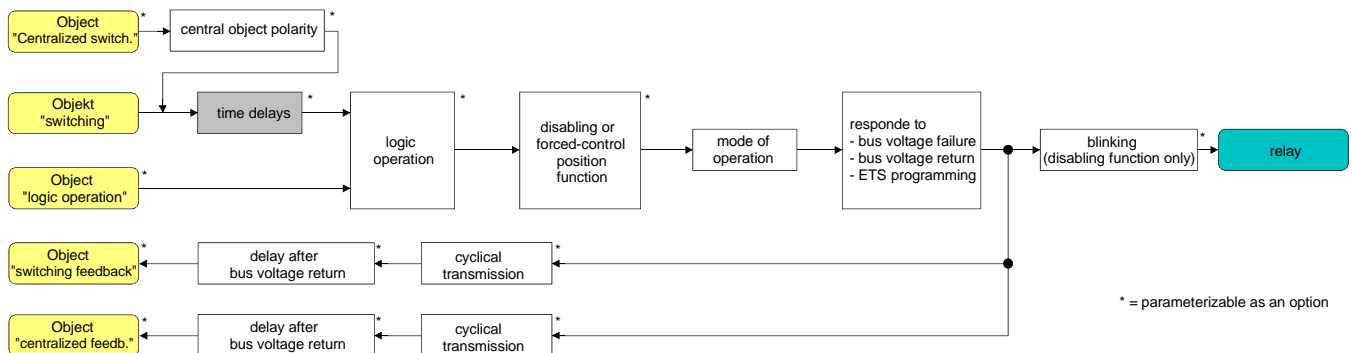

Fig.9: Functional diagram of the time delays

Activating an ON-delay

The time delays must have been enabled on parameter page "Ax – Enabled functions (x = number of output).

- Set the parameter "Selection of time delay" on parameter page "Ax – Time delays" to "ON-delay" or to "ON-delay and OFF delay".

The ON-delay is now enabled and the desired ON-delay time can be preset. After reception of an ON telegram, a parameterized time is started. A subsequent ON-telegram retriggers the time only if the parameter "ON-delay retriggerable ?" has been set to "Yes". The logical switching state will then be transferred to the following functions (e.g. logical operation, disabling / forced-control position function) and the output switched on, only after the ON-delay has elapsed. An OFF-telegram received during the ON-delay will end the delay. The logical switching state corresponds in this case to "switched off".

Activating an OFF-delay

The time delays must have been enabled on parameter page "Ax – Enabled functions (x = number of output).

- Set the parameter "Selection of time delay" on parameter page "Ax – Time delays" to "OFF-delay" or to "ON-delay and OFF delay".

The OFF-delay is now enabled and the desired OFF-delay time can be preset. After reception of an OFF-telegram, a parameterized time is started. A subsequent OFF-telegram retriggers the time only if the parameter "OFF-delay retriggerable ?" has been set to "Yes". The logical switching state will then be transferred to the following functions (e.g. logical operation, disabling / forced-control position function) and the output switched off, only after the OFF-delay has elapsed. An ON-telegram received during the OFF-delay will end the delay. The logical switching state corresponds in this case to "switched on".

- ❶ Feedback: If a time delay has been preset and if the switching state is changed via the "Switching" object, the time delay must have elapsed before feedback telegrams will be transmitted. Updates of the object from "ON" to "ON" or from "OFF" to "OFF" by retriggering during a running time delay has no influence on the switching status feedback.
- ❶ At the end of a disabling or forced-control position function, the state received during or set before the function can be tracked. Residual times of time functions are tracked, if they have not completely elapsed at the time the disabling or forced-control position functions are disabled. In case of a logical operation function, a switching state newly received via the "Switching" object will be executed with a time delay as well.
- ❶ The time delays have no influence on the staircase functions, if these are enabled.
- ❶ A time delay in progress will be completely terminated by a reset of the actuator (bus voltage failure or ETS programming)

Staircase function

The staircase function can be parameterized for each output separately and used for realizing time-controlled staircase lighting or functionally similar applications. The staircase function must have been enabled on parameter page "Ax – Enabled functions" separately for each output before the required communication objects and parameters (on parameter page "Ax – Staircase function") are visible.

The staircase function is controlled by means of the "Staircase function start / stop" communication object and is independent of the "Switching" object of the output (cf. Fig. 10). This feature permits 'parallel operation' of time and normal control, with always the last command being executed.

A telegram to the "Switching" object or a scene recall during an active staircase function ends the staircase time prematurely and sets the output to the switching state corresponding to the object value (time delays taken into account) or the scene value received. Similarly, the switching state of the "Switching" object or a scene recall can be overridden by a staircase timer function.

In combination with a disabling function a time-independent permanent lighting function can also be realized (cf. "Disabling function").

As can be seen from the functional diagram, the staircase function can also be combined with other output functions. The combination with the logic function is, however, not available.

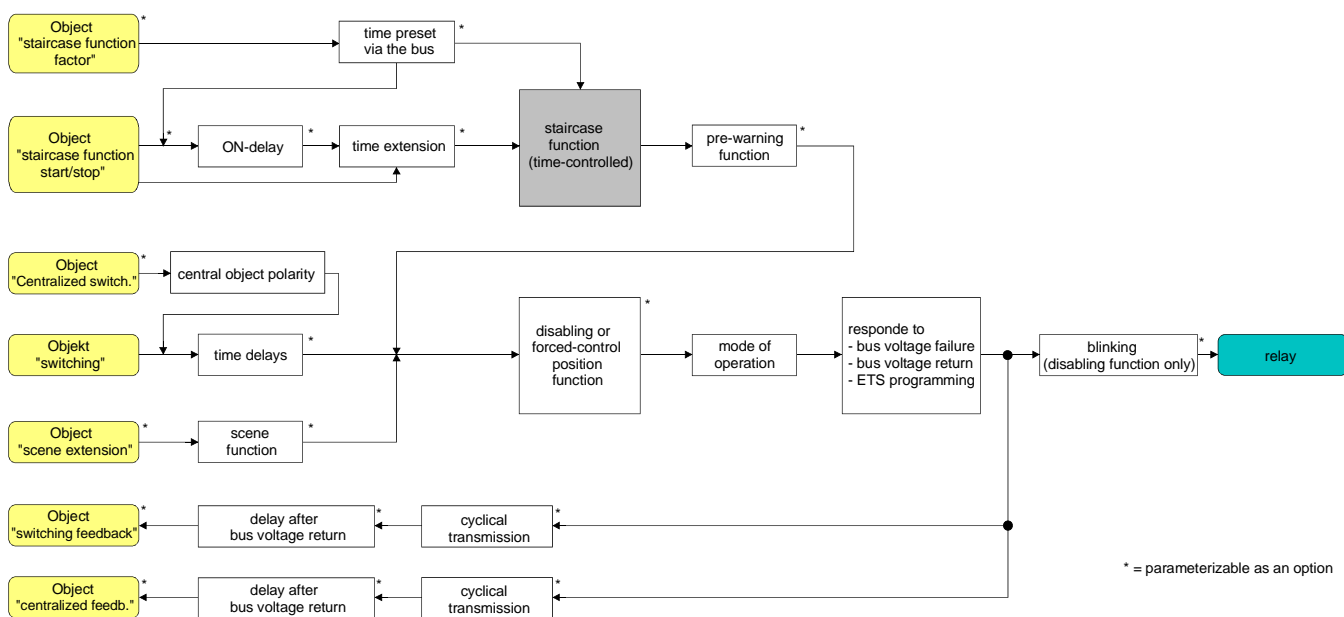

Fig. 10: Functional diagram of the staircase function

The staircase function can be enlarged by a supplementary function with the possibility of activating a time extension. By means of the object "Staircase function start / stop", the "time extension" permits retriggering an activated staircase time n times. As an alternative, "Time preset via the bus" can be selected. With this supplementary function, the parameterized staircase time can be multiplied with a factor received from the bus and thus dynamically adapted.

The staircase function can moreover be enlarged by a separate ON-delay and by a pre-warning function. In acc. with DIN 18015-2, the pre-warning function is designed to warn a person in the staircase that the lights will go out shortly.

Defining the switch-on behaviour of the staircase function

An ON-telegram to the "Staircase function start / stop" activates the staircase lighting time (T_{ON}) the duration of which is defined by the parameter "Staircase time". In addition, an ON-delay (T_{del}) can be activated (cf. "Presetting the ON-delay for the staircase function"). At the end of the staircase lighting time, the output switches off or optionally activates the pre-warning time ($T_{pre-warn}$) of the pre-warning function (cf. "Presetting the pre-warning function of the staircase function"). With a possible ON-delay and a pre-warning function, the staircase function has the switch-on behaviour as shown in Fig. 11.

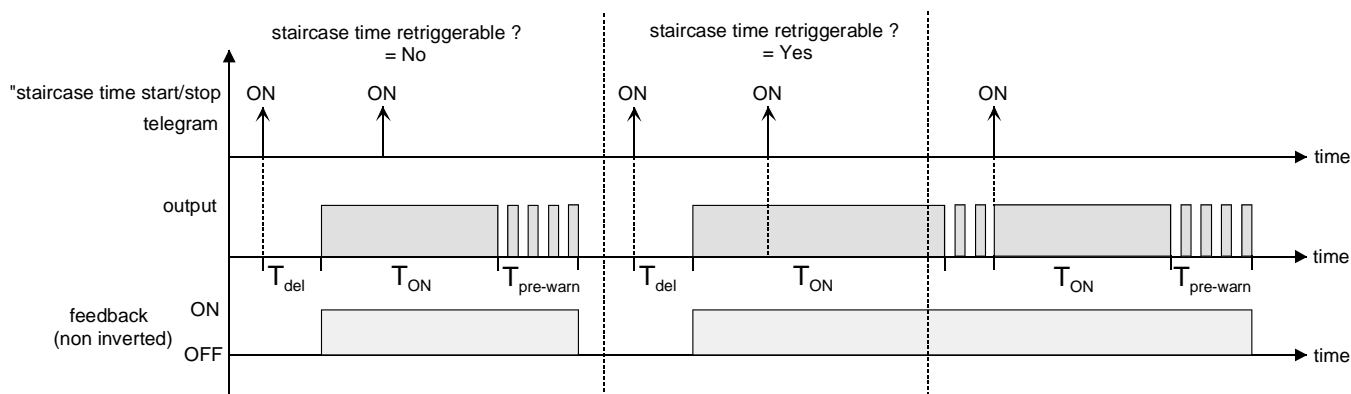

Fig. 11: Switch-on behaviour of the staircase function

The parameter "Staircase time retriggerable ?" defines whether the staircase lighting time can be re-triggered or not.

The staircase function must have been enabled on parameter page "Ax – Enabled functions (x = number of output).

- Set the parameter "Staircase time retriggerable ?" to "Yes".
Every ON-telegram received during the ON-phase of the staircase lighting time re-triggers the staircase time completely.
- Set the parameter "Staircase time retriggerable ?" to "No".
ON-telegrams received during the ON-phase of the staircase time will be rejected. The staircase lighting time will not be re-triggered.

- ❗ An ON-telegram received during the pre-warning time always re-triggers the staircase lighting time independent of the "Staircase time retriggerable ?" parameter.
- ❗ If the supplementary function "Time extension" is active, the "Staircase time retriggerable ?" parameter cannot be changed. In this case, the parameter is set to "No" and cannot be changed.

Defining the switch-off behaviour of the staircase function

In a staircase function, the reaction to an OFF-telegram to the "Staircase function start / stop" object can also be parameterized. Without reception of an OFF-telegram, the output switches off after the pre-warning time has elapsed. With a possible ON-delay and a pre-warning function, the staircase function has a switch-off behaviour as shown in Fig. 12.

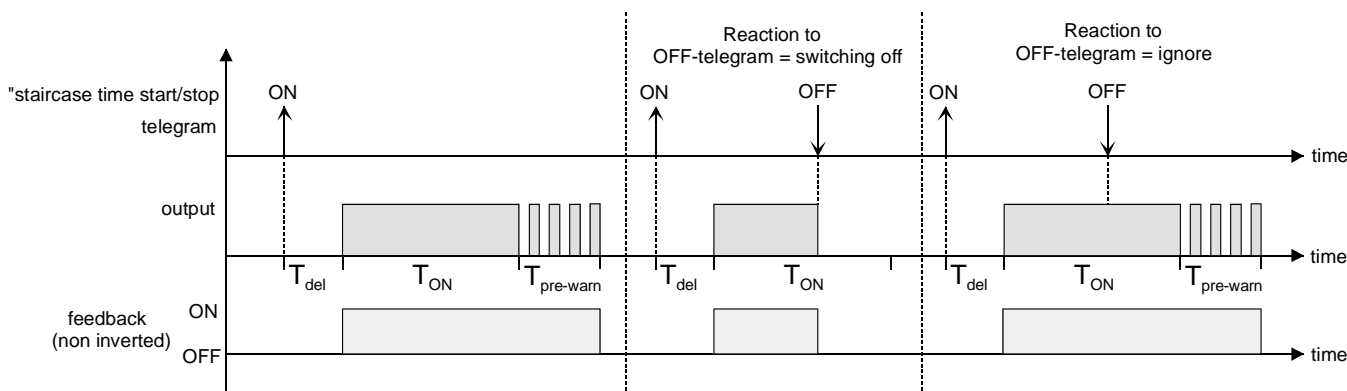

Fig. 12: Switch-off behaviour of the staircase function

The parameter "Reaction to OFF-telegram" defines whether the staircase time (T_{ON}) of the staircase function can be stopped prematurely.

The staircase function must have been enabled on parameter page "Ax – Enabled functions (x = number of output).

- Set the parameter "Reaction to OFF-telegram" to "Switching off"
The output shuts off immediately when an OFF-telegram is received via the object "Staircase function start / stop" during the ON-phase of the staircase time. If the staircase time is stopped prematurely by such a telegram, there is no pre-warning, i.e. the pre-warning time is not started.
- Set the parameter "Reaction to OFF-telegram" to "Ignore".
OFF-telegrams received during the ON-phase of the staircase time will be rejected. The staircase time will be executed completely, if applicable with a pre-warning.

i In the supplementary function "Time preset via the bus", the staircase time of the staircase function can also be started by the reception of a new time factor (cf. "Supplementary function of the staircase function – time preset via bus"). A factor of "0" received in this case will be interpreted as an OFF-telegram. The parameter "Reaction to OFF-telegram" is evaluated in this case, too, so that a staircase time can be terminated prematurely.

Presetting the ON-delay for the staircase function

An ON-telegram to activate the staircase function can also be evaluated with a time delay. This ON-delay can be activated separately for the staircase function and has no influence on the parameterizable time delays for the "Switching" object.

The staircase function must have been enabled on parameter page "Ax – Enabled functions (x = number of output).

- Set the parameter "Activate ON-delay for staircase function ?" on parameter page "Ax – Staircase function" to "Yes".

The ON-delay for the staircase function is now enabled and the desired ON-delay time can be preset. The ON-delay is started after reception of an ON-telegram to the "Staircase function start / stop" object. A subsequent ON-telegram retriggers the time only if the parameter "ON-delay retriggerable ?" has been set to "Yes". The staircase time is activated and the output switched on only after the time delay has elapsed.

- ❗ An OFF telegram via the "Staircase function start / stop" object during the ON-delay ends the delay only if the parameter "Reaction to OFF telegram" is set to "switching off". Otherwise the OFF telegram will be ignored.
- ❗ If the supplementary function "Time extension" is set, the "On-delay retriggerable ?" parameter cannot be changed. In this case, the parameter is set to "No" and cannot be changed.

Presetting the pre-warning function of the staircase function

The pre-warning function complies with DIN 18015-2 and is designed to warn a person in the staircase that the lights will go out shortly. As a pre-warning, the lamps connected to the output are switched off several times for a short instant before the output is shut off definitely. The pre-warning time ($T_{\text{pre-warn}}$), the duration of the interruptions during the pre-warning ($T_{\text{interrupt}}$) and the number of pre-warning interruptions can be parameterized (cf. Fig. 13 - example). The pre-warning time is added to the staircase lighting time (T_{ON}). The pre-warning time has an influence on the value of the feedback object so that the value "0" (non-inverted transmission) is tracked in the feedback object only after the pre-warning time has elapsed.

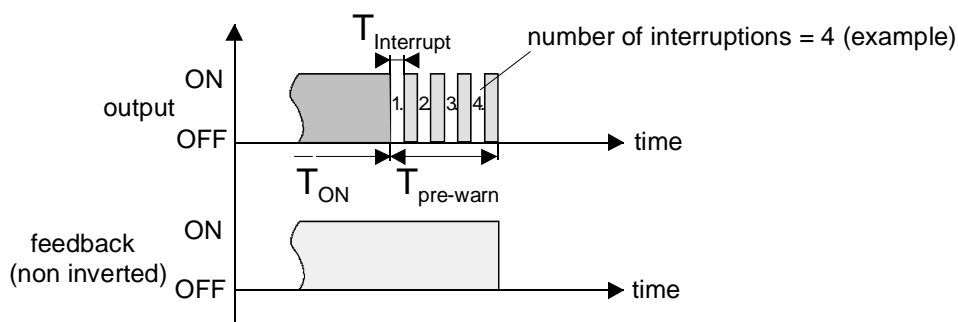

Fig.13: The pre-warning function of the staircase function

The staircase function must have been enabled on parameter page "Ax – Enabled functions (x = number of output).

- Set the parameter "Activate pre-warning time ?" on parameter page "Ax – Staircase function" to "Yes".

The pre-warning function is now enabled and the desired pre-warning time ($T_{\text{pre-warn}}$) can be preset.

- Set the parameter "Number of pre-warnings" on parameter page "Ax – Staircase function" to the desired value (1...10).

The lamps connected to the output will then be switched off exactly as many times as programmed in this parameter. The 1st pre-warning is always executed at the beginning of the total pre-warning time.

- Set the parameter "Time for pre-warning interruptions" on parameter page "Ax – Staircase function" to the desired value.

An interruption ($T_{\text{interrupt}}$) during the pre-warning time is as long as programmed in this parameter. A presettable interruption time permits adapting the shut-off phase of the lighting individually to the lamp type used.

- ⓘ It must be ensured that the "Number of pre-warnings" and the "Time for pre-warning interruptions" are coordinated with the length of the total "pre-warning time". Thus, the total shut-off phase during a pre-warning ("Number of pre-warnings" + "Time for pre-warning interruptions") must not be chosen longer than the pre-warning time itself. Otherwise risk of malfunctions.
- ⓘ The actuator takes its power supply completely from the bus and switches the output relays only after a sufficient amount of energy has been stored. This means that the switching states cannot always be tracked because of the simultaneous state changes occurring when pre-warnings are active on several outputs at the same time. In case of simultaneous pre-warnings on several outputs the number of pre-warnings programmed should therefore be kept conveniently small.
- ⓘ With an ON-telegram to the "Staircase function start / stop" object during an active pre-warning function, the pre-warning time is stopped and the staircase time always restarted (independent of the "Staircase time retriggerable ?" parameter). The parameter "Reaction to OFF-telegram" is also evaluated during the pre-warning time so that an active pre-warning can be terminated prematurely by switching off.

Presetting the staircase lighting timer supplementary function "Time extension"

With the time extension function, the staircase time can be retriggered several times (i.e. extended) via the "Staircase function start/stop" object. The duration of the extension is defined by repeated operation of a control device (several ON-telegrams in succession). The parameterized staircase time can thus be extended by the parameterized factor (max. 5-fold). The extension is then always automatically added to the end of a simple staircase time (T_{ON}) (cf. Fig. 14).

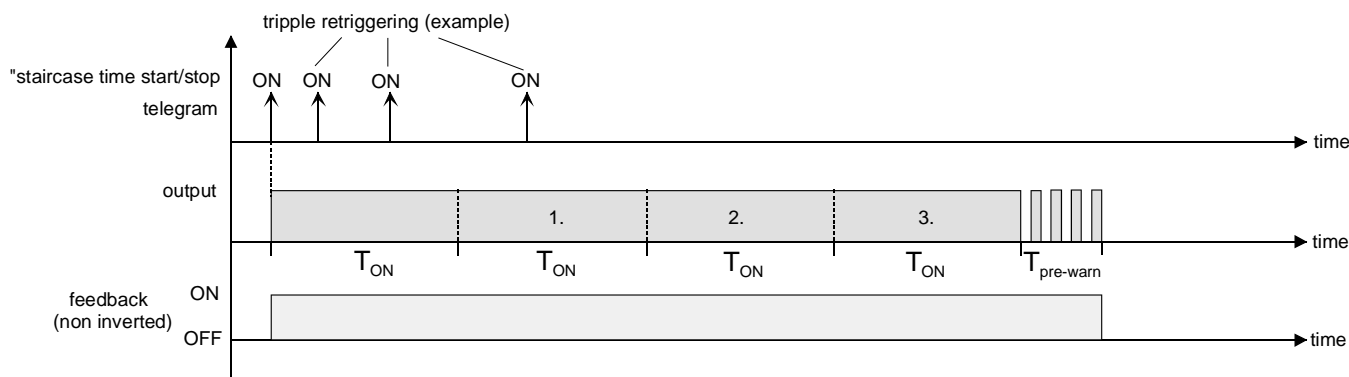

Fig. 14: Time extension for staircase lighting function

With this function, the lighting time in a staircase can be extended (e.g. by a person after shopping) by a defined length without having to retrigger the lighting every time the lighting shuts off automatically. The staircase function must have been enabled on parameter page "Ax – Enabled functions (x = number of output).

- Set the parameter "Supplementary function for staircase function" on parameter page "Ax – Staircase function" to "Time extension" and select the desired factor in the "Maximum time extension" parameter.

On reception of an ON-telegram to the "Staircase function start/stop" object, the staircase time is retriggered at the end of the ON-time as often as determined by the number of telegrams received, however, no longer as permitted by the parameterized factor.

Thus, the setting "3-fold" means that the started staircase time can be automatically retriggered at maximum three more times after elapsing. This means that the time corresponds to 4 times the basic time (cf. Fig. 14).

- ❗ Triggering of an extension can occur during the whole staircase time (T_{ON}). There is no restriction as to the time between two telegrams triggering an extension. Time extension telegrams are evaluated only during the staircase time. An ON-telegram during the pre-warning time triggers the staircase time like in a new start making another time extension possible. If an ON-delay has been programmed, the time extension request is evaluated already during the ON-delay.
- ❗ If a time extension has been parameterized as supplementary function, the parameters "Staircase time retriggerable?" and "ON-delay retriggerable?" are fixed to "No" since retriggering is effected by the time extension.

Presetting the staircase lighting timer supplementary function "Time preset via the bus"

With the time preset via the bus function, the parameterized staircase time can be multiplied with an 8-bit factor received from the bus and thus dynamically adapted. In this setting, the factor is derived from the "Staircase function factor" object. The factor for setting the staircase time lies in a range between 1...255.

The overall staircase time is the product of the factor (object value) and the base (parameterized staircase time) as follows...

Staircase time = (staircase time object value) x (staircase time parameter)

Example:

object value "Staircase function factor" = 5; parameter "Staircase time" = 10s.

→ staircase time selected = 5 x 10s = 50 s.

As an alternative, it is possible to define in the parameters of the staircase function whether the reception of a new factor starts at the same also the staircase time of the staircase function. In this case, the "Staircase function start/stop" object is not existing and starting and stopping is controlled by the factor value received.

The staircase function must have been enabled on parameter page "Ax – Enabled functions (x = number of output).

- Set the parameter "Supplementary function for staircase function" on parameter page "Ax – Staircase function" to "Time preset via the bus" and the parameter "Staircase function activatable via object 'Staircase function factor' ?" to "No".

The staircase time can be adapted dynamically by means of the "Staircase function factor" object. A value of "0" is interpreted as a value of "1". Starting and stopping of the staircase function is effected exclusively via the "Staircase function start/stop" object.

- Set the parameter "Supplementary function for staircase function" on parameter page "Ax – Staircase function" to "Time preset via the bus" and the parameter "Staircase function activatable via object 'Staircase function factor' ?" to "Yes".

The staircase time can be adapted dynamically by means of the "Staircase function factor" object. In addition, the staircase function is started on reception of a new factor with the new staircase lighting time (the "Staircase function start/stop" object is not existing. A factor value of "0" is interpreted as an OFF-telegram with the parameterized reaction to an OFF-telegram being evaluated in this case, too.

A large staircase with several floors is a good example for a possible application of the 'time preset via the bus' function with automatic starting of the staircase lighting time. A touch sensor on each floor of the house transmits a factor value to the staircase function. The higher the floor, the greater the transmitted factor value in order to ensure that the lights remain on longer when it takes more time to reach the upper floors. When a person enters the staircase of the house and after pressing of the touch sensor key, the staircase lighting time is now dynamically adapted and the lighting switched on at the same time.

- ❏ The staircase function is started with the reception of a new factor: A factor of > 0 received during the pre-warning time always re-triggers the staircase lighting time independent of the "Staircase time re-triggerable ?" parameter.
- ❏ After a reset (bus voltage return or programming with the ETS), the "Staircase function factor" object is always initialized with a "1". This alone is not sufficient for automatic starting of the staircase function (cf. "Presetting the behaviour of the staircase function after bus voltage return").
- ❏ The two supplementary functions "Time extension" and "Time preset via the bus" can now be parameterized as an alternative for one another.

Presetting the behaviour of the staircase function after bus voltage return

The staircase function can optionally be started automatically after bus voltage return.

The staircase function must have been enabled on parameter page "Ax – Enabled functions (x = number of output).

- Set the parameter "Behaviour after bus voltage return" on parameter page "Ax – General" to "Activate staircase function".

The staircase lighting time of the staircase function is started immediately after bus voltage return.

- ❗ For this setting it is indispensable that the staircase function has been programmed and enabled beforehand. When the staircase function has not been enabled, this setting will produce no reaction after return of the bus voltage.
- ❗ During an automatic start of the staircase function after return of the bus voltage, an ON-delay – even if parameterized in the staircase function – will not be started.
- ❗ The actuator takes its power supply completely from the bus and switches the output relays only after a sufficient amount of energy has been stored. For this reason, there may be a brief delay after a bus voltage return (5 s max.) before the device adopts the parameterized behaviour.
- ❗ The device adopts the parameterized behaviour only if the last ETS programming of the application or of the parameters occurred at least ca. 20 s ago. Otherwise ($T_{ETS} < 20$ s), the "Behaviour after ETS programming" will be adopted even after a return of bus voltage.
- ❗ The parameterized behaviour will only be adopted, if no forced control is activated after a bus voltage return.
- ❗ A switching state set after bus voltage return will be tracked in the feedback object as provided for in the "Mode of operation" parameter.

Scene function

Up to 8 scenes can be generated and the corresponding scene values stored in the actuator separately for each output. The scene values are recalled or stored via a separate scene extension object by means of extension telegrams. The datapoint type of the extension object permits addressing of up to 64 scenes max. For this reason, the scene number (1...64) with which the internal scene (1...8) is addressed can be determined in the parameterization of a scene.

The scene function must have been enabled on parameter page "Ax – Enabled functions" separately for each output before the required communication objects and parameters (on parameter page "Ax – Scenes") are visible.

The scene function can be combined with other functions of the output (cf. Fig. 15) with the command last received or selected always being executed:

A telegram to the "Switching" object or a scene recall or a scene storage telegram during an active staircase function ends the staircase lighting time prematurely and sets the output to the switching state corresponding to the object value (time delays taken into account) or the scene value received. Similarly, the output switching state set by the "Switching" object or a scene recall can be overridden by a staircase function or by the result of a logic function.

A combination of the function with cyclical monitoring is not possible.

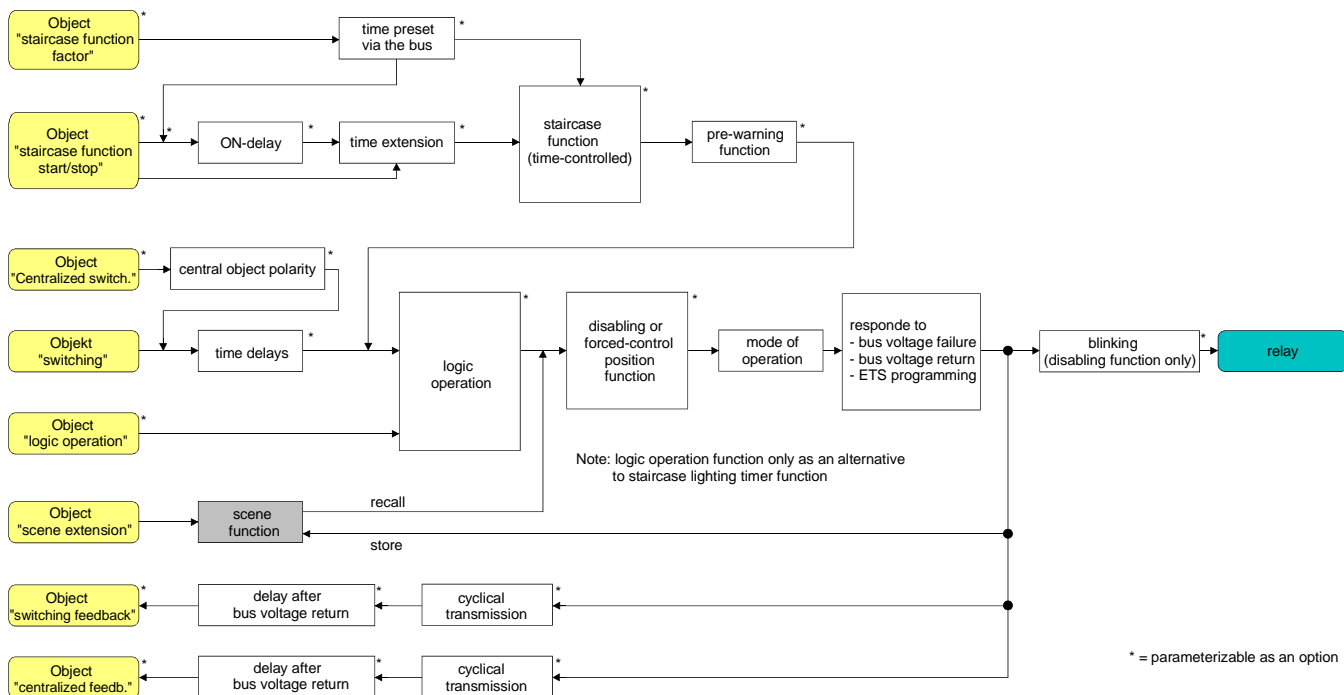

Fig. 15: Functional diagram of the scene function

Presetting a scene recall delay for the scene function

Each scene recall of an output can optionally also be delayed. With this feature, dynamical scene sequences can be configured if several outputs are combined with cyclical scene telegrams.

The scene function must have been enabled on parameter page "Ax – Enabled functions (x = number of output).

- Set the parameter "Delay scene recall?" on parameter page "Ax – Scenes" to "Yes"
The delay time is now activated and can be parameterized separately. The delay only influences the scene recall of the output. The delay time is started on arrival of a recall telegram. The corresponding scene will be recalled and the output set to the respective switching state only after this time has elapsed.
- ❗ Each scene recall telegram restarts the delay time and retriggers it. If a new scene recall telegram is received while a delay is active (scene recall not yet executed), the old (and not yet recalled scene) will be rejected and only the scene last received executed.
- ❗ The scene recall delay has no influence on the storage of scene values. A scene storage telegram within a scene recall delay terminates the delay and thus the scene recall.

Presetting the ETS download behaviour for the scene function

During storage of a scene, the scene values are stored permanently in the device (cf. "Presetting the storage behaviour for the scene function"). To prevent the stored values from being replaced during ETS programming of the application or of the parameters by the originally programmed scene switching states, the actuator can inhibit overwriting of the scene values. As an alternative, the original values can be reloaded into the device during each programming run of the ETS.

The scene function must have been enabled on parameter page "Ax – Enabled functions (x = number of output).

- Set the parameter "Overwrite values stored in the device during download ?" on parameter page "Ax – Scenes" to "Yes".
During each ETS programming of the application or of the parameters, the scene values parameterized in the ETS for the output concerned will be programmed into the actuator. Scene values stored in the device by means of a storage function will be overwritten, if any.
- Set the parameter "Overwrite values stored in the device during download ?" on parameter page "Ax – Scenes" to "Yes".
Scene values stored in the device with a storage function will be maintained. If no scene values have been stored, the switching commands last programmed in the ETS remain valid.
- ❗ When the actuator is put into operation for the first time, this parameter should be set to "Yes" so that the output is initialized with valid scene values. Otherwise, the values in the actuator are "0" (off) for all scenes.

Presetting scene numbers and scene switching state for the scene function

The datapoint type of the scene extension object permits addressing of up to 64 scenes max. For this reason, the scene number (1...64) with which the scene is addressed, i.e. recalled or stored, must be determined for each internal scene (1...8) of the output. Moreover, the switching state to be set for the output in case of a scene recall must be specified as well.

The scene function must have been enabled on parameter page "Ax – Enabled functions (x = number of output).

- Set the parameter "Scene x activatable by scene number" (x = number of the scene (1...8)) for each scene on parameter page "Ax – Scenes" to the numbers with which the scenes are to be addressed. A scene can be addressed with the parameterized scene number. A setting of "0" deactivates the corresponding scene so that neither recalling nor storage is possible.
- ❗ If the same scene number is parameterized for several scenes, only the scene with the lowest internal scene number (1...8) will be addressed. The other internal scenes will be ignored in this case.
- Set the parameter "Switching state for scene x" (x = number of the scene (1...8)) on parameter page "Ax – Scenes" for each scene to the desired switching command ("on" or "off").
In case of a scene recall, the parameterized switching command is recalled and the output is set correspondingly.
- ❗ The output is set to the switching command in a scene recall only if no forced-position or disabling function is active.
- ❗ The parameterized switching command is adopted in the actuator during programming with the ETS only if the parameter "Overwrite values stored in the device during an ETS download ?" is set to "Yes".

Presetting the storage behaviour for the scene function

The logical state established at the output in accordance with the functional diagram ("on" or "off") can be stored internally via the extension object during reception of a scene storage telegram. In this case, the switching state can be influenced before the storage by all functions of the output provided the individual functions have been enabled (e.g. also the disabling function, forced-control position function, etc.).

Rule of thumb: The logical state stored is the one that is reported to the bus by the non-inverted feedback telegram or the one that would have been reported back to the bus had the feedback function not been disabled.

The scene function must have been enabled on parameter page "Ax – Enabled functions (x = number of output).

- Set the parameter "Storage function for scene x" (x = number of the scene (1...8)) on parameter page "Ax – Scenes" for each scene to "Yes".
The storage function is activated for the scene in question. On reception of a storage telegram via the "Scene extension" object, the current logical state will be internally stored.
- Set the parameter "Storage function for scene x" (x = number of the scene (1...8)) on parameter page "Ax – Scenes" for each scene to "No".
The storage function is deactivated for the scene in question. A storage telegram received via the "scene extension" object will be rejected.

Operating hours counter

The operating hours counter tracks the ON-time of a switching output. For the operating hours counter an output is actively on, when the relay contact is closed, i.e. when current is flowing to the load. This means that the counter always evaluates closed contacts independent of the selected mode of operation (make or break contact) and of the logical feedback of the switching status.

The operating hours counter sums up the determined ON-time for a closed relay contact precise to the minute rounding the times off to the full hours (cf. Fig. 16). The accumulated operating hours are tracked in a 2-byte counter and stored permanently in the device. The current count can be transmitted cyclically or after the change of a counting interval to the bus via the communication object "Operating hours counter value".

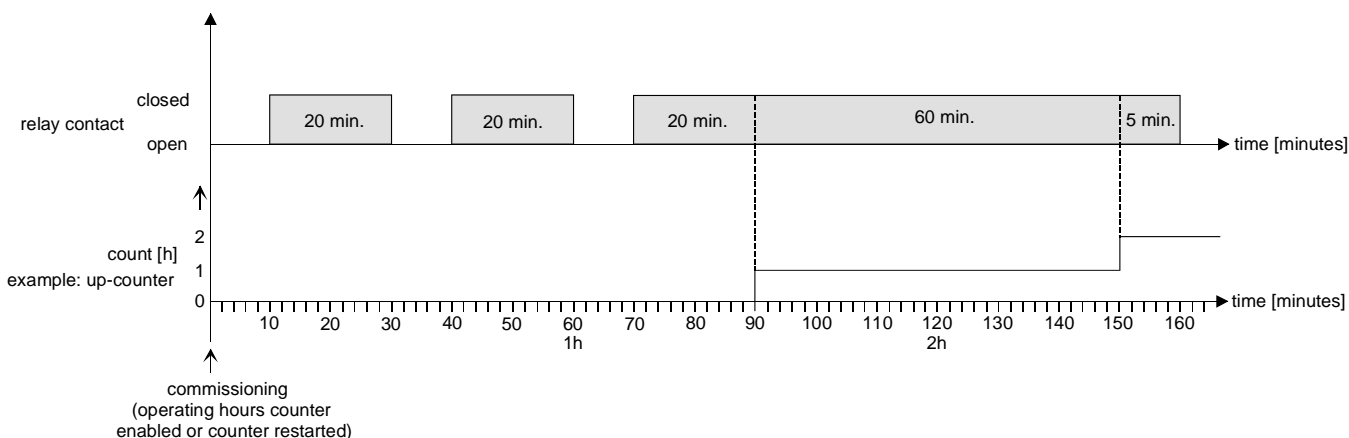

Fig. 16: Functional principle of the operating hours counter

In the state as delivered, all operating hours values of the actuator are zero and no operating hours will be counted if the counter has not been enabled in the parameters of the output concerned. If enabled, the operating hours counter begins counting and summing up the operating hours immediately after commissioning of the actuator.

If an operating hours counter is later on again disabled in the parameters and if it is then programmed with the counter disabled, all operating hours counted beforehand for the output concerned will be deleted. After re-enabling, the operating hours counter always begins with "0".

The operating hours stored in the device (full hours) are not lost after a bus voltage failure or after programming with the ETS. Accumulated operating minutes (full hour not yet reached) are, however, discarded in this case.

After bus voltage return or an ETS download, the actuator passively updates the communication object "Value operating hours counter" for each output. The object value can be read out, if the Read flag is set. The object value, if any, is actively transmitted to the bus depending on the automatic transmission parameters, as soon as the parameterized transmit delay after bus voltage return has elapsed (cf. "Presetting the transmission behaviour of the operating hours counter").

Any manual switching of the relays by means of the slide switches is not detected by the operating hours counter. This means that manual closing of a contact does not activate the operating hours counter and that manual opening does not interrupt a counting cycle in progress.

Activating the operating hours counter

- Set the parameter "Operating hours counter" on parameter page "Ax – Enabled functions" to "Enabled".

The operating hours counter is activated.

Deactivating the operating hours counter

- Set the parameter "Operating hours counter" on parameter page "Ax – Enabled functions" to "Disabled".

The operating hours counter is deactivated.

- ⓘ Disabling of the operating hours counter and subsequent programming with the ETS causes the counter to be reset to "0".

Presetting the counting mode of the operating hours counter

The operating hours counter can be configured as an up-counter or a down-counter. Depending on the above mode, the counter permits presetting a limit or starting value which can be used, for instance, to monitor the hours in operation of a lamp by restricting the counting range.

Up-counter:

After activation of the operating hours counter by enabling it in the ETS or by a restart, the operating hours will be counted started from "0". The maximum counting capacity is 65535 hours. Thereafter, the counter stops and reports reaching the maximum count via the "Runout operating hours counter" object.

As an option, a limit value can be preset either in the ETS or via the communication object "Limit value operating hours counter". In this case, the counting status is reported to the bus via the "Runout operating hours counter" object already when the limit value is reached. If not restarted, the counter will nevertheless continue counting until the max. capacity of 65535 hours is reached and stop thereafter. A new count begins only after the counter is new started.

Down-counter

After enabling the operating hours counter in the ETS, the count is "0" and the actuator reports for the output concerned after programming or after a bus voltage return via the "Runout operating hours counter" object that the counter is running. Only after a restart will the down-counter be preset to the max. value of 65535 and the counting operation be started.

As an option, a start value can be preset either in the ETS or via the communication object "Start value operating hours counter". If a start value has been preset, the down-counter will be initialized after a restart with this value instead of the max. value. The counter will then decrement the hours beginning with the start value. When the down-counter has reached "0", the counting status is reported to the bus via the "Runout operating hours counter" object and counting is stopped. A new count begins only after the counter is new started.

The operating hours counter must have been enabled on parameter page "Ax – Enabled functions (x = number of output).

- Set the parameter "Type of counter" on parameter page "Ax - Operating hours counter" (x = number of output) to "up-counter". If limit value monitoring is desired, set the parameter "Limit value preset?" to "yes, as specified in parameter" or to "yes, as received via object". Otherwise, set the parameter to "no". In the "yes, as specified in parameter" setting, specify the required limit value (0...65535 h).

The counter increments the operating hours beginning with "0". If the limit value monitoring function is active, the actuator sends a "1" telegram for the output concerned via the "Runout operating hours counter" object as soon as the preset limit value is reached. Otherwise, the counter status will be transmitted only after reaching the max. value of 65535.

- Set the parameter "Type of counter" on parameter page "Ax - Operating hours counter" (x = number of output) to "down-counter". If a start value preset is required, set the parameter "Start value preset?" to "yes, as specified in parameter" or to "yes, as received via object". Otherwise, set the parameter to "no". In the "yes, as specified in parameter" setting, specify the required start value (0...65535 h).

After a restart, the counter decrements the operating hours until "0" is reached. If the start value preset mode is active, the counter counts down from the start value. Otherwise, counting begins from the max. value 65535. The actuator sends a "1" telegram for the output concerned via the object "Runout operating hours counter" as soon as "0" is reached.

- ① The value of the communication object "Runout operating hours counter" is stored internally in a non-volatile memory. After bus voltage return or after ETS-programming, the object will be re-initialized with the previously stored value. If an operating hours counter is in this case identified as elapsed, i.e. if the object value is a "1", an additional telegram will be actively transmitted to the bus as soon as the parameterized transmit delay has elapsed after bus voltage return. If the counter has not yet run out (object value "0"), then no telegram will be sent after bus voltage return or programming with the ETS.
- ① In case of start value preset via communication object: The values received via the object will be adopted as valid only after a restart of the operating hours counter and stored internally in a non-volatile memory. After bus voltage return or after ETS-programming, the object will be initialized with the last stored value. The values received are lost during a bus voltage failure or an ETS download, if the counter has not been restarted beforehand. For this reason, it is recommended to always restart the counter whenever a new start or limit value is being preset.
As long as no limit or start value has been received via the object, a fixed standard value of 65535 is the default. The values received via the object and stored will be reset to the default value, if the operating hours counter is disabled in the parameters of the ETS and if an ETS download is made.
 1. In case of limit or start value preset: If the start or limit value is being preset as "0", the following cases must be distinguished...
 - Preset as parameterized: The counter runs out immediately after enabling with ETS download or after a counter restart.
 - Preset via object: A counter restart will be ignored to avoid an undesired reset (e.g. site operation → hours already counted by manual operation).
- ① If the counting direction of an operating hours counter is reversed by parameter change in the ETS, the counter should always be restarted after programming of the actuator to ensure its re-initialization.

Restarting the operating hours counter

The operating hours count can be reset at any time by the "New start operating hours counter" communication object. The polarity of the restart telegram object is fixed. "1" = restart / "0" = no reaction. In case of an up counter, the counter will be initialized during restart with a "0" and in case of a down counter with the start value. If no start value has been parameterized or preset via the object, the start value is fixed with 65535.

During each restart of the counter, the initialized count will be transmitted actively to the bus.

During a restart, the "Runout operating hours counter" message will be reset as well. In this case, a "0" telegram will be transmitted to the bus via the "Runout operating hours counter" object.

In addition, the limit or start value will be initialized as well.

- ❗ If a new limit or start value has been preset via the communication object, the counter should always be restarted thereafter. Otherwise, the received values will be lost during a bus voltage failure or an ETS download.
- ❗ If a start or a limit value is preset with "0", the device will show different reactions during a restart depending on the type of value preset...
 - Preset like parameter:
The counter runs out immediately after a counter restart.
 - Preset via object:
A counter restart will be ignored to avoid an undesired reset (e.g. after installation of the devices with hours already being counted by manual operation). To perform the restart, it is necessary to preset at first a start or limit value greater than "0".

Presetting the transmit behaviour of the operating hours counter

The current value of the operating hours counter is always tracked in the communication object "Value operating hours counter". After bus voltage return or an ETS download the actuator passively updates the communication object "Value operating hours counter" for each output. The object value can be read out, if the "Read" flag is set.

In addition, the transmit behaviour of this communication object can be preset.

The operating hours counter must have been enabled on parameter page "Ax – Enabled functions (x = number of output).

- Set the parameter "Automatic transmission of counting value" on parameter page "Ax – Operating hours counter" (x = number of output) to "after change by interval value". Set the "Counting value interval (1...65535 h)" to the desired value.
 - The count is transmitted to the bus as soon as it changes by the preset count value interval. After bus voltage return or after ETS programming, the object value will be automatically transmitted after the "Delay after bus voltage return" has elapsed, when the current count corresponds to the count value interval or a multiple thereof. A count of "0" will in this case always be transmitted.
- Set the parameter "Automatic transmission of counting value" on parameter page "Ax – Operating hours counter" (x = number of output) to "cyclical".
 - The count value is transmitted cyclically. The cycle time is defined channel-independent on the parameter page "Time settings". After bus voltage return or after programming with the ETS, the count will be transmitted to the bus for the first time after the parameterized cycle time has elapsed.

Supplementary functions

For each output, supplementary functions can be enabled. As supplementary function, a disabling function or alternatively a forced-control position function can be configured. Only one of these functions can be enabled for an output. Additionally, a logical operation function can be parameterized. These additional functions are enabled on parameter page "Ax – Supplementary functions" (x = number of output).

Presetting the disabling function as supplementary function

As can be seen from the functional diagram (cf. Fig. 17), the disabling function can also be combined with other output functions. In case of an active disable, the upstream functions are overridden so that the output concerned will be locked in the disabled state. The override feature can also be used to implement a permanent lighting function.

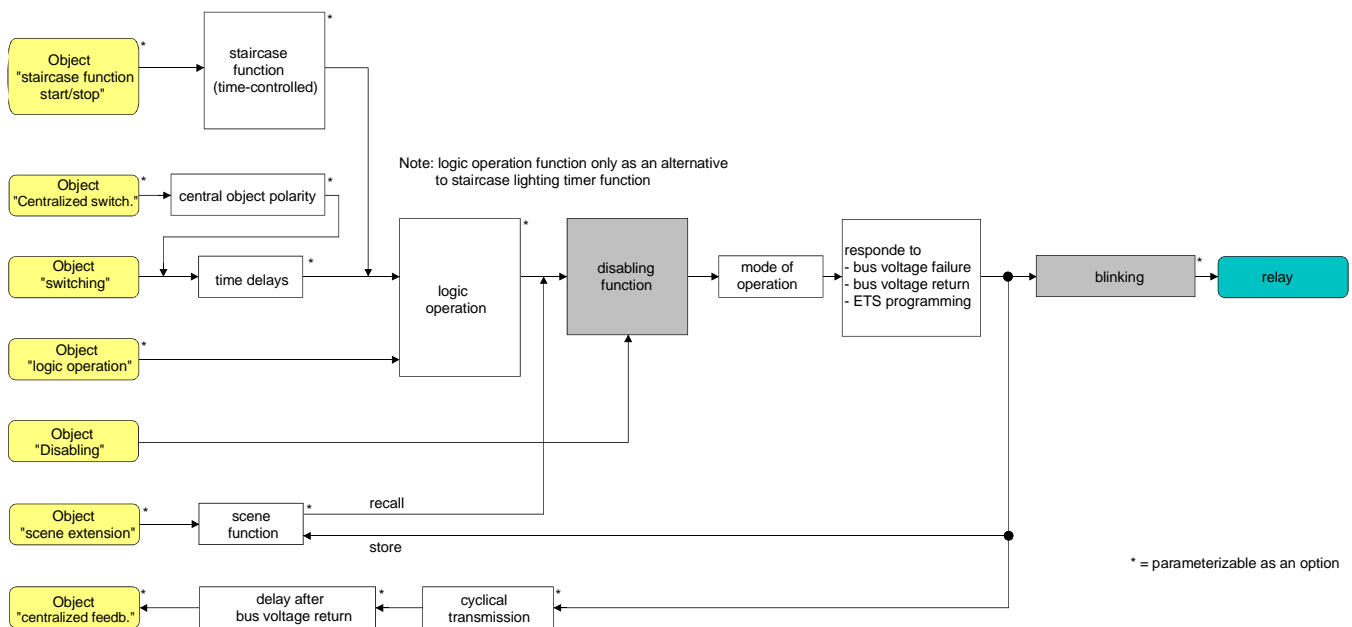

Fig. 17: Functional diagram of the disabling function

- Set the parameter "Selection of supplementary function" on parameter page "Ax – Supplementary functions" to "Disabling function".
The disabling function is enabled. The "Disabling" communication object and the parameters of the disabling function are visible.
- Set the parameter "Polarity of disable object" on parameter page "Ax – Supplementary functions" to the desired polarity.
- ⓘ After bus voltage return or programming of the application or of the parameters with the ETS, the disabling function is always deactivated (object value "0"). In the inverted setting ("1 = enabled; 0 = disabled"), a "0" telegram update must first be sent after the initialization before the disabled state is activated.
- ⓘ Updates of the disabling object from "ON" to "ON" or from "OFF" to "OFF" show no reaction. The relay remains in the position last set, if applicable also set manually.
- ⓘ An output disabled via the bus can still be operated by hand!

- Set the parameter "Behaviour at the beginning of the disabling function" on parameter page "Ax – Supplementary functions" to the desired behaviour.
At the beginning of disabling, the parameterized behaviour will be executed and the output locked. When the setting "No change of switching state" is selected, the relay of the output shows no reaction and remains in the switching state last set (switching state in acc. with last non-inverted feedback telegram). When the setting "Blinking" is selected, the output is switched on and off cyclically during disabling. The blinking time is generally parameterized for all outputs on the "General" parameter page. During blinking, the logic switching state is "ON - 1".
 - Set the parameter "Behaviour at the end of the disabling function" on parameter page "Ax – Supplementary functions" to the desired behaviour.
At the end of disabling, the parameterized behaviour will be executed and the output re-enabled. When the setting "No change of switching state" is selected, the relay of the output shows no reaction and remains in the state last set by the disabling function.
When the setting "Setting tracked state" is selected, the last switching state existing before the disabling function or the switching state internally tracked during the disabling function will be set. In this case, residual times of time functions or of the staircase functions will be tracked as well, if they have not completely elapsed at the time of re-enabling the disabling function. In the settings "No change of switching state", "Switching on", "Switching off" or "Blinking", the states set at the end of the disabling function have no influence on time or staircase functions
When the setting "Blinking" is selected, the output is switched on and off cyclically after disabling. Blinking persists until a new switching state is set. The blinking time is generally parameterized for all outputs on the "General" parameter page. During blinking, the logic switching state is "ON - 1".
- ❗ The states defined for the end of the disabling function override a logic function if parameterized. The parameterized logic operation will be executed and the result forced on the output only if at least one input state of the logic operation changes or is updated after the disabling state has been suspended.
- ❗ **Blinking:** The actuator takes its power supply completely from the bus and switches the output relays only after a sufficient amount of energy has been stored. In case of blinking with short intervals this means that switching states cannot always be tracked because of the simultaneous state changes in several outputs. For this reason, it is important to program sufficiently long blinking rates if several outputs are to blink at the same time.

Presetting the forced-control position function as supplementary function

As can be seen from the functional diagram (cf. Fig. 18), the forced-control position function can also be combined with other output functions. In case of an active forced-control position function, the upstream functions are overridden so that the output concerned will be locked in the forced position.

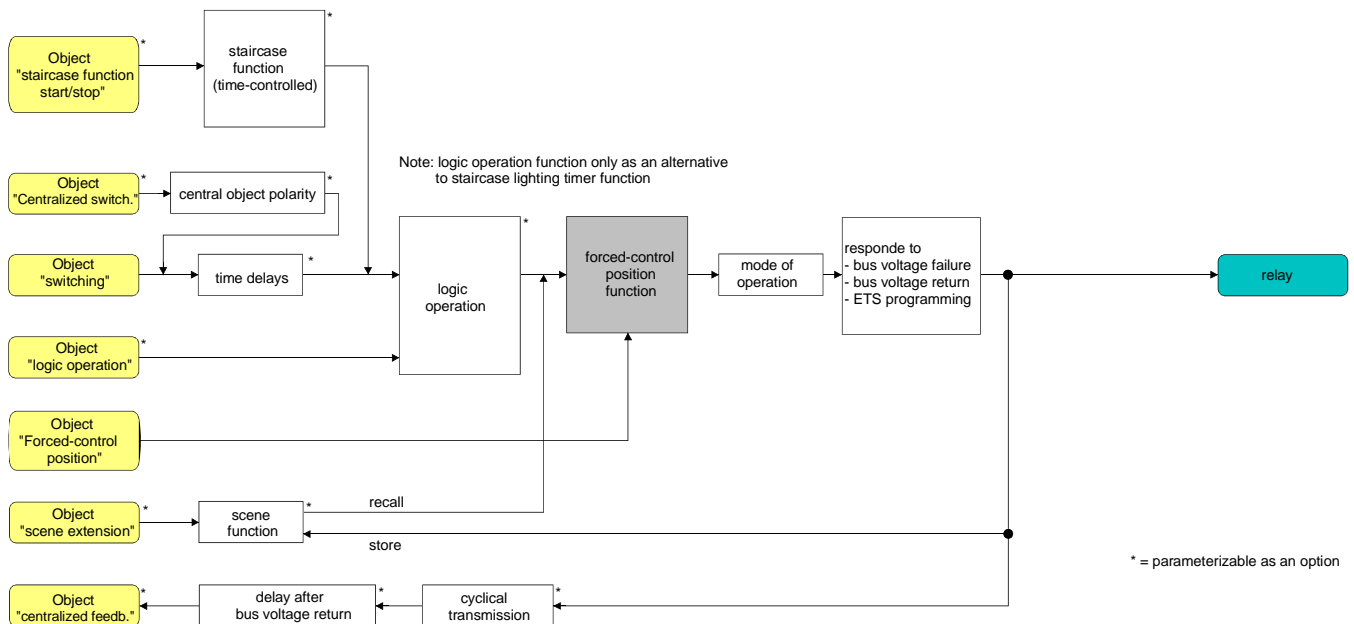

Fig. 18: Functional diagram of the forced-control position function

- Set the parameter "Selection of supplementary function" on parameter page "Ax – Supplementary functions" to "Forced-control position".

The forced-control position function is enabled. The "Forced-control position" communication object and the parameters of the forced-control position function are visible.

In case of the 2-bit forced-control position, the switching state of the output is directly determined by the forced-control position telegram. The first bit (bit 0) of the "Forced-control position" object specifies the switching state to be forced on the output. The second bit (bit 1) activates or deactivates the forced control (cf. table 1).

| Bit 1 | Bit 0 | Function |
|-------|-------|---|
| 0 | x | forced-control position not active ⇔ normal control |
| 0 | x | forced-control position not active ⇔ normal control |
| 1 | 0 | forced-control position active: switching off |
| 1 | 1 | forced-control position active: switching on |

Table 1: Bit coding of forced-control position

- ⓘ Updates of the forced-control position object from "Forced-control position ON" to "Forced-control position ON" will cause the relay every time to switch the contact into the forced-control position. Updates from "Forced-control position OFF" to "Forced-control position OFF" remain without effect.
- ⓘ An output under forced control from the bus can still be operated by hand!

- Set the parameter "Behaviour at the end of the forced-control position function" on parameter page "Ax – Supplementary functions" to the desired behaviour.

At the end of the forced-control position function, the parameterized behaviour will be executed and the output re-enabled for normal control. When the setting "No change of switching state" is selected, the relay of the output shows no reaction and remains in the state last set by the forced-control position function.

When the setting "Tracking the switching state" is selected, the switching state last existing before forced control or the one tracked internally while the forced-control position function was active will be set at the end of the forced-control position function. In this case, residual times of time functions or of the staircase functions will be tracked as well, if they have not completely elapsed at the time of re-enabling the disabling function. In the settings "No change of switching state", "Switching on" or "Switching off", the states set at the end of the forced-control position function have no influence on time or staircase functions.

- ❗ The states defined for the end of the forced-control position function override a logic function if so parameterized. The parameterized logic operation will be executed and the result forced on the output only if at least one input state of the logic operation changes or is updated after the forced-control state has been suspended.

The communication object of the forced-control position function can be initialized after bus voltage return. In this way, the switching state of the output can be influenced when the forced-control position function is activated.

- Set the parameter "Behaviour after bus voltage return" on parameter page "Ax – Supplementary functions" to the desired behaviour.

After bus voltage return, the parameterized state is adopted in the "Forced-control position" communication object. In case of an active forced position, the output will be switched immediately after bus voltage return to the corresponding state and locked by forced control until the forced-position condition is cancelled via the bus. The parameter "Behaviour after bus voltage return" will in this case not be evaluated for the output concerned.

If "State of forced-control as before bus voltage failure" is selected, the forced-control is set to the state which was stored in a non-volatile memory at the time of bus voltage failure. After programming of the application or of the parameters with the ETS, the value is in this case always internally set to "Not active".

- ❗ After bus voltage return or programming of the application or of the parameters with the ETS, the forced-control position function is always deactivated (object value "0").

Presetting the logic function as supplementary function

A logic function can be parameterized separately and independently for each output. This function permits linking the state of the "Switching" object with an additional logic operation object. The state of the communication object for "Switching" can also be evaluated with a delay when an ON-delay or an OFF-delay are defined.

As can be seen from the functional diagram (cf. Fig. 19), the logic function can also be combined with other output functions. A combination with the staircase or the cyclical monitoring function is, however, not possible.

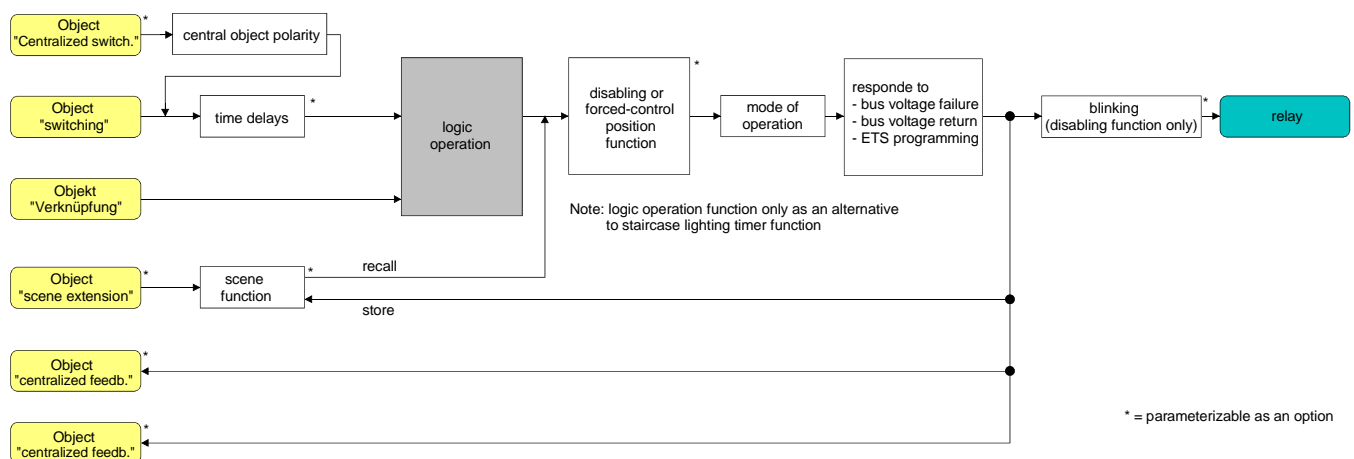

Fig. 19: Functional diagram of the logic function

The following gating operations can be parameterized (cf. Fig. 20)

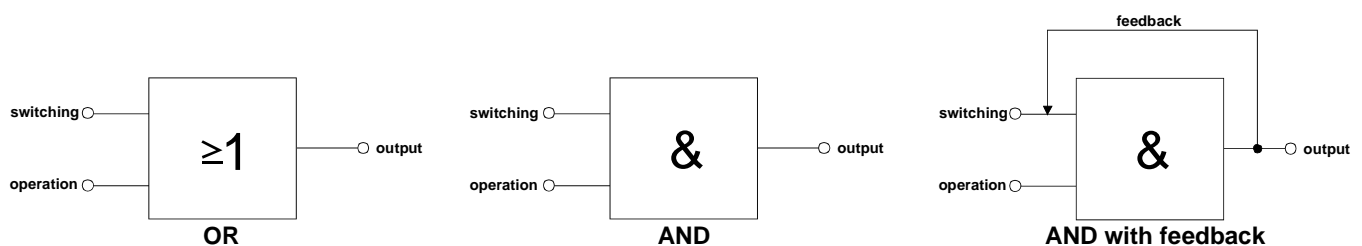

Fig. 20: Gating operations of the logic function

i "AND with feedback:"

With a logic object = "0", the output is always "0" (logic AND). In this case, the feedback signal from the output to the "switching" input will directly reset this input when it is being set. Only if the logic operation object = "1", can the output adopt the logic state "1" after a new "1" has been received on the "Switching" input.

The "Logic operation" object can be initialized after bus voltage return or programming with the ETS with a previously parameterized value so that in case of a telegram update to the "Switching" object a correct operation result is determined immediately and the output set correspondingly.

- Set the parameter "Logic operation function ?" on parameter page "Ax – Supplementary functions" to "Yes".

The logic function is enabled. The "Logic operation" communication object and the parameters of the logic function are visible.

- Set the parameter "Type of logic operation" on parameter page "Ax – Supplementary functions" to the desired type of logic operation.

- Set the parameter "Value of logic operation object after bus voltage return" and "Value of logic operation object after ETS download" on parameter page "Ax – Supplementary functions" to the desired initial conditions.

After bus voltage return or after ETS programming of the application software or of the parameters, the "Logic operation" object is initialized with the preset switching states"

- ❗ After an actuator reset (bus voltage return or ETS programming), the logic function will be executed only if at least one input object of the logic operation is updated by means of a telegram from the bus.

- ❗ The states preset for the end of a disabling or forced-control position function or the switching states that are set after ETS programming, bus voltage failure or after bus voltage return will override the logic function. The parameterized logic operation will be executed and the result forced on the output only if at least one input state of the logic operation changes or is updated.

4.2.4.3 Delivery state

The actuator is delivered with no application program loaded. The relays can be operated manually. There is no feedback to the bus in this case.

The device can be programmed and put into operation with the ETS. The physical address is preset to 15.15.255.

4.2.5 Parameters

| Description: | Values: | Remarks: |
|---|---|---|
|  General | | |
| Delay after bus voltage return Minutes (0...59) | 0...59 | To reduce telegram traffic on the bus line after bus voltage activation (bus reset), after connection of the device to the bus line or after programming with the ETS, it is possible to delay all active feedbacks of the actuator. The parameter specifies in this case a delay for all devices. Feedback telegrams for initialization will be transmitted to the bus only after the parameterized delay time has elapsed, if the feedback telegrams are to be transmitted with a time delay. Setting the minutes of the delay time. |
| Seconds (0...59) | 0...17...59 | Setting the seconds of the delay time. |
| Central function ? | yes no | Setting "yes" enables the central function and thus the "Central switching" object. Individual switching outputs can be assigned to the central function only if the function is enabled |
| Central object polarity | 0 = switching off ; 1 = switching on 0 = switching on; 1 = switching off | The parameter sets the polarity of the central object. |

| | | |
|--|--|---|
| <p>Make use of centralized feedback ?</p> | <p>no yes, active message object yes, passive status object</p> | <p>To keep the telegram load low during a 'bus initialization', the centralized feedback function of the actuator can be employed. Setting "yes" activates the centralized feedback and enables the corresponding object. The parameter moreover defines whether the feedback telegrams are transmitted actively (telegram transmission in case of changes) or passively (telegram transmission only as a response to a 'Read' request). The communication flags of the object are automatically set by the ETS according to the setting.</p> |
| <p>Time delay for feedback telegram after bus voltage return ?</p> | <p>yes no</p> | <p>The centralized feedback telegram can be transmitted to the bus with a delay after bus voltage return or after programming with the ETS. Setting "Yes" activates the delay time of the centralized feedback in case of bus voltage return. The delay time is parameterized under "General" (see above).</p> |
| <p>Cyclical transmission of centralized feedback telegram ?</p> | <p>Yes (transm. cyclic and in case of changes)</p> | <p>The object value of the centralized feedback can be transmitted cyclically.</p> |
| | <p>No (transmission only in case of changes)</p> | <p>The feedback telegram is transmitted to the bus cyclically and after state changes. The cycle time is generally programmed under the "Time settings" entry for all feedback telegrams. The feedback telegram is transmitted to the bus only after state changes. i This parameter is visible as an active message object only if centralized feedback is enabled.</p> |

Blinking rate **1 s**
 2 s
 5 s
 10 s

At the beginning and at the end of a disabling function (if used), switching outputs can also be parameterized as "blinking". In this case, the outputs change the switching state cyclically. The "Blinking rate" parameter generally defines the ON-time and the OFF-time of a "blinking" output signal for all outputs.

Example:
Blinking rate = 1 s
→ 1 s off → 1 s on → 1 s off ...

i The actuator takes its power supply completely from the bus and switches the output relays only after a sufficient amount of energy has been stored. In case of blinking with short blinking rate this means that switching states cannot always be tracked because of the simultaneous state changes in several outputs. For this reason, it is important to program sufficiently long blinking rate if several outputs are to blink at the same time.

 Time settings

Time for cycl. monitoring **0...23**
Hours (0...23)

If desired, outputs can be assigned independent of one another to the cyclical monitoring function. If no telegram update on the "Switching" object has been received after the monitoring time has elapsed, the corresponding output relay is set to its default position. The parameter "Time for cycl. monitoring" generally defines the monitoring time for all outputs.

Setting the monitoring time hours.

Minutes (0...59) **0...2...59**

Setting the monitoring time minutes.

| | | |
|---|-------------------|---|
| Seconds (10...59) | 10...59 | Setting the monitoring time seconds. <i>Default setting: 2 minutes 10 seconds</i> |
| Time for cyclical transmission of feedback tel. Hours (0...23) | 0...23 | Depending on parameterization, the different active feedback telegrams of the actuator can transmit their state also cyclically to the bus. The parameter "Time for cyclical transmission of feedback tel." generally defines the cycle time for all outputs. Setting the cycle time hours. |
| Minutes (0...59) | 0...2...59 | Setting the cycle time minutes. |
| Seconds (10...59) | 10...59 | Setting the cycle time seconds. <i>Default setting: 2 minutes 10 seconds</i> |
| Time for cyclical transmission operating hours Hours (0...23) | 0...23 | Depending on parameterization, the operating hours counters of the outputs can also transmit their count cyclically to the bus. The parameter "Time for cyclical transmission operating hours" generally defines the cycle time for all outputs. Setting the cycle time hours. |
| Minutes (0...59) | 0...59 | Setting the cycle time minutes. |
| Seconds (10...59) | 10...59 | Setting the cycle time seconds. <i>Default setting: 23 hours 0 minutes 10 seconds</i> |

 Ax – General (x = number of output / All outputs can be parameterized independent of one another.)

| | | |
|---------------------------------|-----------------------|--|
| Mode of operation | | The relays of a switching output can be parameterized as make or break contacts. This feature offers the possibility of inversion the switching states. |
| | (make contact) | Switching state = off ("0") → relay contact open Switching state = on ("1") → relay contact closed |
| | break contact | Switching state = off ("0") → relay contact closed Switching state = on ("1") → relay contact open |
| Behaviour after ETS programming | | The actuator permits setting the preferred relay contact position after ETS programming separately for each output. |
| | close contact | The relay contact is closed after an ETS programming cycle. |
| | open contact | The relay contact is opened after an ETS programming cycle. |
| | no reaction | After ETS programming, the relay of the output shows no response and remains in the switching state last selected. |
| | |  The parameterized behaviour will be executed after every application or parameter download by the ETS. A simple download of the physical address alone or partial programming of only the group addresses has the effect that this parameter is disregarded and that the parameterized "Behaviour after bus voltage return" will be executed |

Behaviour in case of bus
voltage failure

close contact

The actuator permits setting the preferred relay contact position in case of bus voltage failure separately for each output.

open contact

The relay contact is closed on bus voltage failure.

no reaction

The relay contact is opened on bus voltage failure.

In case of bus voltage failure, the relay of the output shows no reaction and remains in the switching state last selected.

| | | |
|------------------------------------|--|---|
| Behaviour after bus voltage return | | The actuator permits setting the preferred relay contact position after bus voltage return separately for each output. |
| | close contact | The relay contact is closed after bus voltage return. |
| | open contact | The relay contact is opened after bus voltage return. |
| | state as before bus voltage failure | After bus voltage return, the switching state last selected before bus voltage failure and internally stored on bus voltage failure will be retained. |
| | no reaction | After bus voltage return, the relay of the output shows no reaction and remains in the switching state last selected. |
| | activate staircase function (if parameterized) | <p>The staircase lighting function is activated after bus voltage return independent of the "Switching" object. For this setting it is indispensable that the staircase lighting function has been programmed and enabled beforehand. When the staircase function has not been enabled, this setting will produce no reaction after return of the bus voltage.</p> <p>i The device adopts the parameterized behaviour only if the last ETS programming of the application or of the parameters ended at least ca. 20 s ago. Otherwise ($T_{ETS} < 20$ s), the "Behaviour after ETS programming" will be adopted also in case of bus voltage return.</p> <p>i The parameterized behaviour will only be adopted, if no forced control is activated after bus voltage return.</p> <p>i The actuator takes its power supply completely from the bus and switches the output relays only after a sufficient amount of energy has been stored. For this reason, there may be a brief delay after a bus voltage return (5 s max.) before the device adopts the parameterized behaviour.</p> |

| | | |
|---|---|--|
| Assignment to central function ? | | This parameter determines the assignment of the output to the central function. |
| | yes (enable central function under "General") | The output is assigned to the central function. The central function is supposed to have been enabled under "General". The assignment has otherwise no effect on the switching output. |
| | no | The output is not assigned to the central function. |
| Feedback telegram ? | | The current switching state of the output can be reported back separately to the bus. |
| | none | No feedback object available for the output. Feedback deactivated. |
| | no inversion, active message object | Feedback and object are activated. The state is transmitted in non-inverted form. The object transmits actively. |
| | no inversion, passive status object | Feedback and object are activated. The state is transmitted in non-inverted form. The object is passive (telegram transmission only as a response to 'Read' request). |
| | inversion, active message object | Feedback and object are activated. The state is transmitted in inverted form. The object transmits actively. |
| | inversion, passive status object | Feedback and object are activated. The state is transmitted in inverted form. The object is passive (telegram transmission only as a response to 'Read' request). <i>i</i> The communication flags of the object are automatically set by the ETS according to the setting. |
| Time delay for feedback telegram after bus voltage return ? | yes (delay time under "General") | The feedback telegram can be transmitted to the bus with a delay after bus voltage return or after programming with the ETS. Setting "Yes" activates the delay time of the feedback in case of bus voltage return. The delay time is parameterized under "General". |
| | no | <i>i</i> This parameter is visible as an active message object only if feedback is enabled. |

Cyclical transmission of
feedback telegram ?

yes (transm. cyclic and in
case of changes)

The object value of the feedback can be
transmitted cyclically.



The feedback telegram is transmitted to the
bus cyclically and after state changes.
The cycle time is generally programmed
under the "Time settings" entry for all feed-
back telegrams.



**no (transmission only in
case of changes)**



The feedback telegram is transmitted to the
bus only after state changes.

This parameter is visible as an active
message object only if feedback is en-
abled.

 Ax – Enabled functions (x = number of output / All outputs can be parameterized independent of one another.)

| | | |
|-------------------------------------|---|---|
| Assignment to cyclical monitoring ? | <p>no</p> <p>yes, "ON" when time has elapsed</p> <p>yes, "OFF" when time has elapsed</p> | <p>This parameter determines the assignment to cyclical monitoring of the output.</p> <p>Cyclical monitoring deactivated.</p> <p>Cyclical monitoring activated. The actuator expects a telegram update to the "Switching" object within the monitoring time parameterized under "Time settings". Otherwise, the output will be brought into the predefined contact position and activated when the monitoring time has elapsed.</p> <p>Cyclical monitoring activated. The actuator expects a telegram update to the "Switching" object within the monitoring time parameterized under "Time settings". Otherwise, the output will be brought into the predefined contact position and deactivated when the monitoring time has elapsed.</p> <ul style="list-style-type: none">  An output in preferred contact position is not locked so that new telegram updates to the "Switching" object will again be evaluated and processed normally.  The disabling or forced-control position function has a higher priority than the cyclical monitoring function.  When cyclical monitoring is activated, it is not possible to program the functions delay times, staircase timer, logic operation and scene. |
| Time delays | <p>disabled</p> <p>enabled</p> | <p>This parameter can be used to disable or to enable the time delays. When the function is enabled, the corresponding parameters will be displayed under "Ax - Time delays"</p> |
| Staircase function | <p>disabled</p> <p>enabled</p> | <p>This parameter can be used to disable or to enable the staircase function. When the function is enabled, the corresponding parameters will be displayed under "Ax - Staircase function" and the necessary object enabled.</p> |

| | | |
|---|---|--|
| Scene function | disabled enabled | This parameter can be used to disable or to enable the scene function. When the function is enabled, the corresponding parameters will be displayed under "Ax - Scenes" and the necessary object enabled. |
| Operating hours counter | disabled enabled | This parameter can be used to disable or to enable the operating hours counter. When the function is enabled, the corresponding parameters will be displayed under "Ax - Operating hours counter" and the necessary object enabled.  Disabling of the operating hours counter will cause any operating hours counted beforehand to be deleted and limit or start values set via the object for the output concerned to be reset. |
|  Ax – Time delays (x = number of output / only visible if parameter "Time delays" under "Ax – Enabled functions" is set to "enabled"!) | | |
| Selection of time delay | no time delay OFF-delay ON-delay ON-delay and OFF-delay | The communication object "Switching" can be evaluated with a time delay. This parameter selects the desired mode of operation of the time delay and enables the other delay parameters. |
| ON-delay Hours (0...23) | 0...23 | This parameter is used for programming the duration of the ON-delay Setting the ON-delay hours. |
| Minutes (0...59) | 0...59 | Setting the ON-delay minutes. |
| Seconds (0...59) | 0...30...59 | Setting the ON-delay seconds. <i>Presetting: 30 seconds</i> |
| ON-delay retriggerable ? | yes no | An active ON-delay can be retriggered by another "1" telegram (setting "yes"). Alternatively, retriggering can be excluded (setting "no").  The ON-delay parameters are only visible, if the parameter "Selection of time delay" is set to "ON-delay" or to "ON-and OFF-delay". |

| | | |
|--|-----------------------------|---|
| OFF-delay Hours (0...23) | 0...23 | <p>This parameter is used for programming the duration of the OFF-delay</p> <p>Setting the OFF-delay hours.</p> |
| Minutes (0...59) | 0...59 | Setting the OFF-delay minutes. |
| Seconds (0...59) | 0...30...59 | <p>Setting the OFF-delay seconds.</p> <p><i>Presetting: 30 seconds</i></p> |
| OFF-delay retriggerable ? | <p>yes</p> <p>no</p> | <p>An active OFF-delay can be retriggered by another "0" telegram (setting "yes"). Alternatively, retriggering can be excluded (setting "no").</p> <p> The OFF-delay parameters are only visible, if the parameter "Selection of time delay" is set to "OFF-delay" or to "ON-and OFF-delay".</p> |
| <p> Ax – Staircase function (x = number of output / only visible if parameter "Staircase function" under "Ax – Enabled functions" is set to "enabled"!)</p> | | |
| Staircase time Hours (0...23) | 0...23 | <p>This parameter is used for programming the duration of the staircase lighting time.</p> <p>Setting the staircase lighting time hours.</p> |

| | | |
|--------------------------------|---|---|
| Minutes (0...59) | 0... 3 ...59 | Setting the staircase lighting time minutes. |
| Seconds (0...59) | 0 ...59 | Setting the staircase lighting time seconds. <i>Presetting:3 minutes</i> |
| Staircase time retriggerable ? | yes no | An active staircase lighting time can be retriggered (setting "yes"). Alternatively, retriggering can be excluded (setting "no"). <i>[i]</i> This parameter is fixed to "no", when the supplementary function "Time extension" is parameterized. In this case, retriggering is not possible. |
| Reaction to OFF telegram | switch off ignore | An active staircase lighting time can be stopped prematurely by deactivating the staircase lighting time. The staircase lighting time is stopped after reception of an OFF-telegram to the "Staircase function start/stop" object. In the supplementary function "Time preset via the bus" with the setting "Activate staircase function via 'Staircase time' object ? = Yes", the staircase lighting time can also be stopped prematurely by inserting a factor of "0". OFF-telegrams or factors of "0" will be ignored. The staircase time will be executed completely. |

| | | |
|--|---|--|
| Supplementary function for staircase function | | The staircase function can be enlarged by two supplementary functions to be used alternatively. This parameter enables the desired supplementary function and activates the necessary parameters or objects. |
| | no supplementary function | No supplementary function enabled. |
| | time extension | Time extension is activated. This function permits retriggering an activated staircase lighting time span n-times via the object "Staircase function start/stop". |
| | time preset via the bus | Time preset via the bus is active. With this supplementary function, the parameterized staircase time can be multiplied with a factor received from the bus and thus dynamically adapted. |
| Max. time extension | 1-fold 2-fold 3-fold 4-fold 5-fold | <p>In case of a time extension (retriggering the lighting time n-times via the object "Staircase function start/stop"), the parameterized staircase lighting time will be extended by the value programmed in this parameter.</p> <p>1-fold extension means that the started staircase time can be automatically retriggered at maximum one more time after elapsing. The lighting time is thus doubled. The other setting options apply analogously.</p> <p>i This parameter is visible only when the supplementary function "Time extension" is active.</p> |
| Staircase function activatable via object "Staircase function factor"? | yes no | <p>In case of time preset via the bus, this parameter can be used to define whether the reception of a new time factor also starts the ON-time of the staircase function as well. The object "Staircase function start/stop" is then hidden.</p> <p>When the setting is "no", the ON-time can only be activated via the object "Staircase function start/stop".</p> <p>i This parameter is visible only when the supplementary function "Time preset via the bus" is active.</p> |

| | | |
|---|----------------------|--|
| <p>Activate ON-delay for staircase function ?</p> | <p>yes</p> <p>no</p> | <p>The staircase function permits activating its own ON-delay. This ON-delay function acts on the trigger event of the staircase function and therefore delays switching on.</p> <p>The ON-delay is enabled.</p> <p>The ON-delay is disabled.</p> <p>i The ON-delay parameterized under this item is independent of the other time functions of the actuator. It only acts on the staircase function and not on the "Switching" object.</p> |
| <p>ON-delay Hours (0...23)</p> | <p>0...23</p> | <p>This parameter is used for programming the duration of the ON-delay</p> <p>Setting the ON-delay hours.</p> |
| <p>Minutes (0...59)</p> | <p>0...59</p> | <p>Setting the ON-delay minutes.</p> |
| <p>Seconds (0...59)</p> | <p>0...30...59</p> | <p>Setting the ON-delay seconds.</p> <p><i>Presetting: 30 seconds</i></p> |
| <p>ON-delay retriggerable ?</p> | <p>yes</p> <p>no</p> | <p>An active ON-delay can be retriggered (setting "yes"). Alternatively, retriggering can be excluded (setting "no").</p> <p>i This parameter is fixed to "no", when the supplementary function "Time extension" is parameterized. In this case, retriggering is not possible.</p> <p>i The ON-delay parameters are only visible, if the parameter "Activate ON-delay for staircase function ?" is set to "yes".</p> |
| <p>Activate pre-warning time ?</p> | <p>yes</p> <p>no</p> | <p>When the staircase time of a staircase timer function has elapsed, the output can activate the pre-warning function. The pre-warning function is designed to warn a person in the staircase that the lights will go out shortly.</p> <p>The pre-warning function is activated.</p> <p>The pre-warning function is deactivated.</p> |

| | | |
|---|--------------------|--|
| Pre-warning time Minutes (0...59) | 0...59 | This parameter is used for programming the duration of the pre-warning time. The pre-warning time is added to the staircase lighting time. Pre-warnings (shutting off the output) will be generated only within the pre-warning time. |
| | | Setting the pre-warning time minutes. |
| Seconds (0...59) | 0...30...59 | Setting the pre-warning time seconds. |
| | | <i>Presetting: 30 seconds</i> |
| | | i A pre-warning time is aborted by retriggering of the staircase function. |
| Number of pre-warnings (1...10) | 1...3...10 | This parameter defines how often the output is to switch off within the pre-warning time. i.e. how many pre-warnings will be generated. |
| Time for pre-warning interruptions Seconds (0...59) | 0...59 | This parameter defines the duration of a pre-warning interruption, i.e. how long the output is to remain off during a pre-warning interruption. The time should be adapted individually to the shut-off behaviour of the lamp type used. |
| | | Setting the pre-warning interruption seconds. |

Milliseconds
(0...9 x 100)

0...5...9



Setting the pre-warning interruption milliseconds.

Presetting: 500 milliseconds

i It must be ensured that the "Number of pre-warnings" and the "Time for pre-warning interruptions" are coordinated with the length of the total "pre-warning time". Thus, the total shut-off phase during a pre-warning ("Number of pre-warnings" + "Time for pre-warning interruptions") must not be chosen longer than the pre-warning time itself. Otherwise risk of malfunctions.



i The actuator takes its power supply completely from the bus and switches the output relays only after a sufficient amount of energy has been stored. This means that the switching states cannot always be retained because of the simultaneous state changes occurring when pre-warnings are active on several outputs at the same time. In case of simultaneous pre-warnings on several outputs the number of pre-warnings programmed should therefore be kept conveniently small.

 Ax – Scenes (x = number of output / only visible if parameter "Scene function" under "Ax – Enabled functions" is set to "enabled!")

| | | |
|--|--|---|
| <p>Delay scene recall ?</p> | <p>yes</p> <p>no</p> | <p>A scene is recalled via the scene extension object. If needed, the scene recall on the actuator can be made with a delay after reception of a recall telegram (setting: "yes"). The recall is alternatively made immediately on reception of the telegram (setting: "no").</p> <p> A recall delay has no influence on the storage of scene values.</p> |
| <p>Delay time Minutes (0...59)</p> | <p>0...59</p> | <p>This parameter is used for programming the duration of delay time</p> <p>Setting the delay time hours.</p> |
| <p>Seconds (0...59)</p> | <p>0...10...59</p> | <p>Setting the delay time seconds.</p> <p><i>Presetting: 10 seconds</i></p> <p> The parameters are only visible, if the parameter "Delay scene recall ?" is set to "yes".</p> |
| <p>Overwrite values stored in the device during download ?</p> | <p>yes</p> <p>no</p> | <p>During storage of a scene, the scene values (current states of the outputs concerned) are stored in the device memory. To prevent the stored values from being replaced during ETS programming of the application or of the parameters by the originally programmed scene switching states, the actuator can inhibit overwriting of the scene values (setting: "no"). As an alternative, the original values can be reloaded into the device during each ETS programming (setting: "yes").</p> |
| <p>Scene X activatable by scene number (scene number "0" = scene deactivated)</p> <p><i>X = depending on the scene (1...8)</i></p> | <p>0...64; 1*</p> <p><i>*: The predefined scene number is dependent on the scene (1...8).</i></p> | <p>The actuator distinguishes between up to 8 different scenes which are recalled via the scene extension object or stored. The datapoint type of the extension object permits addressing of up to 64 scenes max. This parameter defines the scene number (1...64) which is used to address the internal scene.</p> <p>A setting of "0" deactivates the corresponding scene.</p> |

| | | |
|---|--|--|
| Switching state for scene X <i>X = depending on the scene (1...8)</i> | switching on switching off | This parameter is used for programming the switching command which is executed when the scene is recalled. |
| Storage function for scene X <i>X = depending on the scene (1...8)</i> | yes no | The "yes" setting enables the storage function of the scene. If the function is enabled, the current logic switching state (on / off) can be stored internally via the extension object during reception of a scene storage telegram. If "no" is selected, the storage telegrams are rejected. |

 Ax – Operating hours counter (x = number of output / only visible if parameter "Operating hours counter" under "Ax – Enabled functions" is set to "enabled!")

| | | |
|---------------------------|---|---|
| Type of counter | <p>up-counter</p> <p>down-counter</p> | <p>The operating hours counter can be configured as up counter or down counter. The setting has an influence on the visibility of the other parameters and objects of the operating hours counter.</p> |
| Limit value preset ? | <p>no</p> <p>yes, as specified in parameter</p> <p>yes, as received via object</p> | <p>If the up counter is used, a limit value can be preset as an option. This parameter defines whether the limit value can be preset in a separate parameter or individually adapted from the bus by an independent communication object. A setting of "no" deactivates the limit value.</p> <p> This parameter is only visible in the configuration "Type of counter = up counter".</p> |
| Limit value (0...65535 h) | 0... 65535 | <p>This parameter is used for setting the limit value of the up counter. On reaching this limit value, a "1" telegram is transmitted via the "Runout operating hours counter" object. The counter itself continues to run until the max. count (65535) is reached and stops.</p> <p> This parameter is only visible, if the parameter "Limit value preset ?" is set to "yes, as specified in parameter".</p> |
| Start value preset ? | <p>no</p> <p>yes, as specified in parameter</p> <p>yes, as received via object</p> | <p>If the down counter is used, a start value can be preset as an option. This parameter defines whether the start value can be preset in a separate parameter or individually adapted from the bus by an independent communication object. A setting of "no" deactivates the start value.</p> <p> This parameter is only visible in the configuration "Type of counter = down counter".</p> |

| | | |
|--|---------------------------------------|---|
| Start value (0...65535 h) | 0... 65535 | <p>This parameter is used for setting the start value of the down counter. After the initialization, the counter begins to decrement the hours from the preset value to "0". After reaching the final value, a "1" telegram is transmitted via the "Runout operating hours counter" object.</p> <p>i This parameter is only visible, if the parameter "Start value preset ?" is set to "yes, as specified in parameter".</p> |
| Automatic transmission of counting value | | <p>The current count of the operating hours counter can be actively transmitted to the bus via the communication object "Operating hours counter value".</p> |
| | cyclical transmission | <p>The count is transmitted to the bus cyclically and after a change. The cycle time is programmed under the "Time settings" entry for all outputs in common.</p> |
| | after change by interval value | <p>The count is transmitted to the bus only after a change.</p> |
| Counting value interval (1...65535 h) | 1...65535 | <p>This parameter is used for setting the counting value interval for automatic transmission. The current count will be transmitted to the bus after the time interval programmed in this parameter.</p> <p>i This parameter is only visible, if the parameter "Automatic transmission of counting value ?" is set to "transmission after change by interval value".</p> |

 Ax – Supplementary functions (x = number of output)

| | | |
|-------------------------------------|---|---|
| Selection of supplementary function | no supplementary function disabling function forced-control position | This parameter can be used to define and to enable the supplementary function. The disabling function can only be parameterized as an alternative to the forced-control position function. |
| Polarity of disable object | 0 = enabled; 1 = disabled 1 = enabled; 0 = disabled | This parameter defines the polarity of the disabling object.  After bus voltage return or programming of the application or of the parameters with the ETS, the disabling function is always deactivated (object value "0"). In the inverted setting ("1 = enabled; 0 = disabled"), a "0" telegram update must first be sent after the initialization before the disabled state can be activated. |

Behaviour at the beginning of the disabling function

The behaviour of the output at the beginning of the disabling function can be parameterized.

no change of switching state

At the beginning of the disabling function, the relay of the output shows no reaction and remains in the current switching state. Thereafter, the output is locked.

switching off

The output switches off at the beginning of the disabling function and goes into lock.

switching on

The output switches on at the beginning of the disabling function and goes into lock.

blinking

The output blinks on and off during disabling and is locked during this time. The blinking time is generally parameterized for all outputs under "General". During blinking, the logic switching state is "ON - 1".

i Blinking: The actuator takes its power supply completely from the bus and switches the output relays only after a sufficient amount of energy has been stored. In case of blinking with short blinking rate this means that switching states cannot always be tracked because of the simultaneous state changes in several outputs. For this reason, it is important to program sufficiently long blinking rate if several outputs are to blink at the same time.

i An output disabled via the bus can still be operated by hand!

i This parameter is only visible, if the parameter "Selection of supplementary function" is set to "disabling function".

Behaviour at the end of the disabling function:

| | |
|------------------------------|--|
| | The behaviour of the output at the end of the disabling function can be parameterized. |
| no change of switching state | At the end of disabling, the internal switching state is not changed. Thereafter, the output is again enabled. |
| switching off | At the end of disabling, the switching state is set to off. The output is re-enabled. |
| switching on | At the end of disabling, the switching state is set to on. The output is re-enabled. |
| setting tracked state | At the end of disabling, the last switching state existing before the disabling function or the switching state internally tracked during the disabling function will be set. In this case, residual times of time functions or of the staircase functions will be tracked as well, if they have not completely elapsed at the time of re-enabling the disabling function. |
| blinking | <p>At the end of disabling, the output blinks on and off and is re-enabled. Blinking persists until a new switching state is set. The blinking time is generally parameterized for all outputs under "General". During blinking, the logic switching state is "ON - 1".</p> <p>i Blinking: The actuator takes its power supply completely from the bus and switches the output relays only after a sufficient amount of energy has been stored. In case of blinking with a short blinking interval this means that switching states cannot always be tracked because of the simultaneous state changes in several outputs. For this reason, it is important to program sufficiently long blinking intervals if <u>several outputs</u> are to blink at the same time.</p> <p>i This parameter is only visible, if the parameter "Selection of supplementary function" is set to "disabling function".</p> |

Behaviour at the end of the forced-control position

The behaviour of the output at the beginning of a forced-control position function is directly determined by the forced-position telegram. The behaviour of the output at the end of the forced-control position function can be parameterized.

tracking the switching state

At the end of the forced-control position function, the output will be set to the switching state last existing before forced control or to the one tracked internally while forced control was active. In this case, residual times of time functions or of the staircase functions will be tracked as well, if they have not completely elapsed at the time of re-enabling the disabling function.

no change of switching state

At the end of the forced-control position function, the internal switching state will not be changed. Thereafter, the output is again enabled.

switching off

At the end of the forced-control position function, the switching state is set to off. The output is re-enabled.

switching on

At the end of the forced-control position function, the switching state is set to on. The output is re-enabled.

 This parameter is only visible, if the parameter "Selection of supplementary function" is set to "forced-control position".

Behaviour after bus voltage return

The communication object of the forced-control position function can be initialized after bus voltage return. The switching state of the output can be influenced when the forced-control position function is activated.

no forced-control position

No forced-control position activated after bus voltage return.

activate forced-control position, ON

Forced-control position activated. Output re-enabled.

deactivate forced-control position, OFF

Forced-control position activated. The output will be switched off by forced control.

state of forced-control as before bus voltage failure

The output is set to the forced control state which was stored in a non-volatile memory at the time of bus voltage failure. After programming of the application or of the parameters with the ETS, the value is internally set to "not active".

i After programming of the application or of the parameters with the ETS, the forced-control position is always cancelled.

i This parameter is only visible, if the parameter "Selection of supplementary function" is set to "forced-control position".

Logic operation function ? yes

This parameter can be used to enable the logic operation function (setting "yes"). After enabling, the logic operation object and the parameters of the function are visible.

no

i The parameter is fixed to "no", when the staircase lighting timer or the cyclical monitoring functions are enabled.

| | | |
|--|--|--|
| Type of logic operation | <p>OR</p> <p>AND</p> <p>AND with feedback</p> | <p>This parameter defines the type of the logic operation.</p> <p>i "AND with feedback:" With a logic object = "0", the output is <u>always</u> "0" (logic AND). In this case, the feedback signal from the output to the "switching" input will directly reset this input when it is being set. Only if the logic operation object = "1", can the output adopt the logic state "1" after a new "1" has been received on the "Switching" input.</p> <p>i This parameter is only visible, if the parameter "Logic operation function ?" is set to "yes".</p> |
| Value of logic operation object after bus voltage return | <p>0 (OFF)</p> <p>1 (ON)</p> | <p>If logic operation is enabled, the parameter can be used to determine the value with which the logic operation object will be initialized after bus voltage return.</p> <p>i This parameter is only visible, if the parameter "Logic operation function ?" is set to "yes".</p> |
| Value of logic operation object after ETS download | <p>0 (OFF)</p> <p>1 (ON)</p> | <p>If logic operation is enabled, the parameter can be used to determine the value with which the logic operation object will be initialized after ETS programming.</p> <p>i This parameter is only visible, if the parameter "Logic operation function ?" is set to "yes".</p> |